

THANK YOU FOR PURCHASING. THIS IS THE INSTALLATION MANUAL OF WALD FRONT BUMPER FOR BMW G12 7 SERIES.
PLEASE READ THIS MANUAL CAREFULLY BEFORE THE INSTALLATION.

ATTENTION



- ※ NO RETURNS CAN BE ACCEPTED BECAUSE OF IMPROPER INSTALLATION OR PAINTING.
- ※ CHECK THE FITMENT, AND ADJUST ALL THE DETAILS BEFORE PAINTING.
- We assume no responsibility for any damage resulting from improper installation, painting, modification and any cut wound in unsealing.
- Contact the car dealer when you have any question in removing OEM parts.
- During all the installation process, use parking brake and stop the engine completely.
- Use rasps or sandpapers to fit the products to the body if there is an individual difference.
- The product is made of FRP. Handle with care. Do not give the excessive force. Gradually fix the bolts and nuts by checking the fitment and balance of the installation.
- Check the fitment, and adjust all the details of the fitment steady and proper. Please check the fitment and all the details regularly, fix the bolts and nuts as necessary.
- The instruction of painting is just our recommendation, please paint it as you like.
- ※ PLEASE BE AWARE OF:
- You may lose the warranty and all the services from the car maker, because of replacing OEM parts.
- Reduced road clearance may cause inconvenience in using parking curbs and garage jack.
- FRP, ABS and PPE products are slightly weaker than OEM parts in crashes.
- The product may not match the body and OEM color perfectly.

Please purchase double sided tape, primer and caulking glue at auto accessory shop or hardware store.

Completely degrease and paint primer on all the installation positions to enhance the viscosity of double sided tape.
Use dryer to warm double sided tape to enhance the viscosity in low temperature.
Keep the car in a dry condition more than 24 hours after gluing.
Do not wash the car during this time.

	PARTS	QUANTITIES
FRONT BUMPER	FRONT BUMPER	1
	MESHES	1 SET
	LED LAMP	1 SET

Use caulking glue to fill the gap between the product and the body.

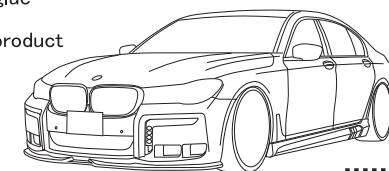

FRONT BUMPER

[BEFORE PAINTING]

- 1) Make the battery off before start working.
- 2) Remove OEM front bumper according to the BMW service manual.
- 3) Take off OEM energy absorber from the body.
- 4) Modify OEM parts on OEM Front Bumper to fit on WALD Front Bumper, then temporarily install on a car. (As per enclosures, 1, 2 and 3)
- 5) Take off WALD Front Bumper from the body after checking the fitting, then prepare to install LED Lamps.
- ※ See the attached installation manual for LED LAMP.
- 6) Paint WALD Front Bumper according to the picture.

[AFTER PAINTING]

- 7) Fix LED Lamps on WALD Front Bumper.
- 8) Install PTS, OEM inner parts, the attached LED lamps and Meshes, then install WALD Front Bumper to the body.
- ※ Make sure the attached LED lamp kit is fine to work before the installation.
- 9) Check all the details of the fitment, then tighten all the bolts and tapping screws.
- 10) Modify the shape of the license plate holder, then fix the license plate on the location not covering the OEM Steering wheel & Lane Control Assist Sensor according to PIC 1.
- 11) Make sure to RESET the computer at the BMW Dealer after detaching the harness of the sensor.

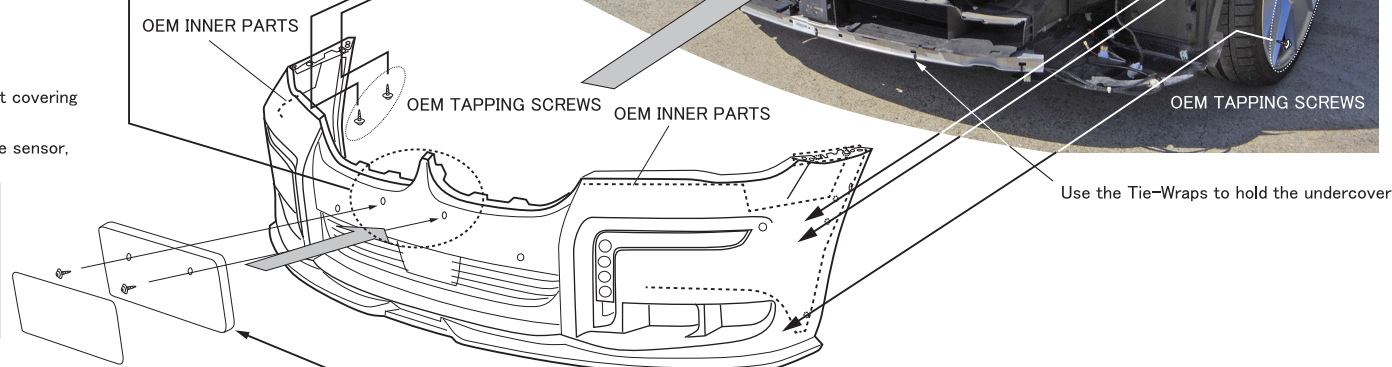
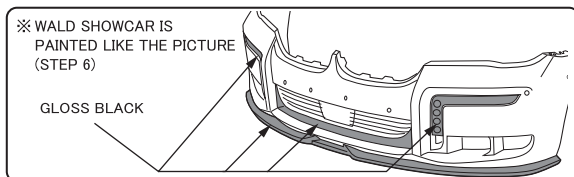
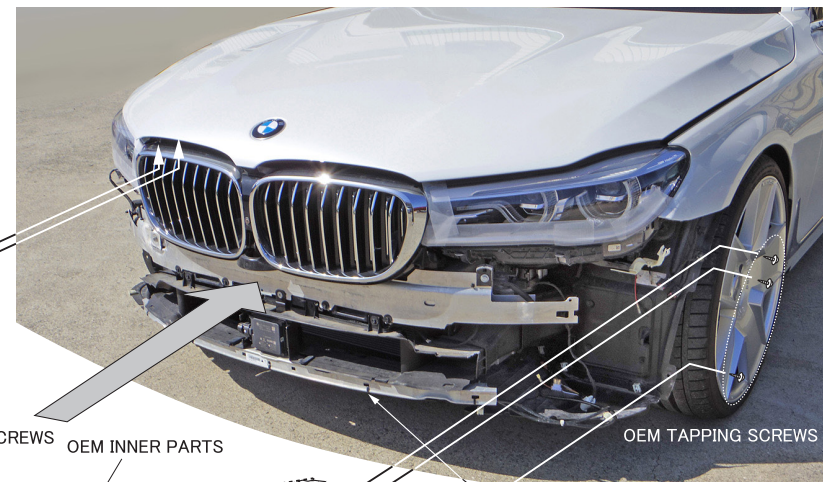
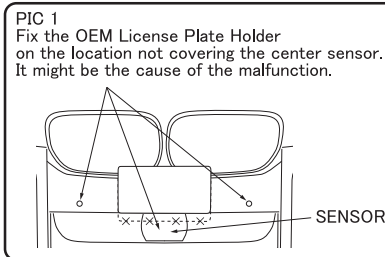

ATTENTION

- ※ MORE THAN 2 TECHNICIANS ARE NECESSARY IN THIS WORK.
- DURING ALL THE INSTALLATION PROCESS, PLEASE BE CAREFUL NOT TO DAMAGE THE BODY.
- ※ ADJUST ALL THE DETAILS OF OUR PRODUCTS TO FIT ON A CAR PERFECTLY.

OEM LICENSE PLATE HOLDER
※Fix on the location Not covering the sensor

THANK YOU FOR PURCHASING. THIS IS THE INSTALLATION MANUAL OF HOW TO ADJUST OEM INNER PARTS TO FIT WITH WALD FRONT BUMPER FOR BMW G12 7 SERIES.
PLEASE READ THIS MANUAL CAREFULLY BEFORE THE INSTALLATION.

HOW TO FIX OEM FRONT INNER PARTS 1

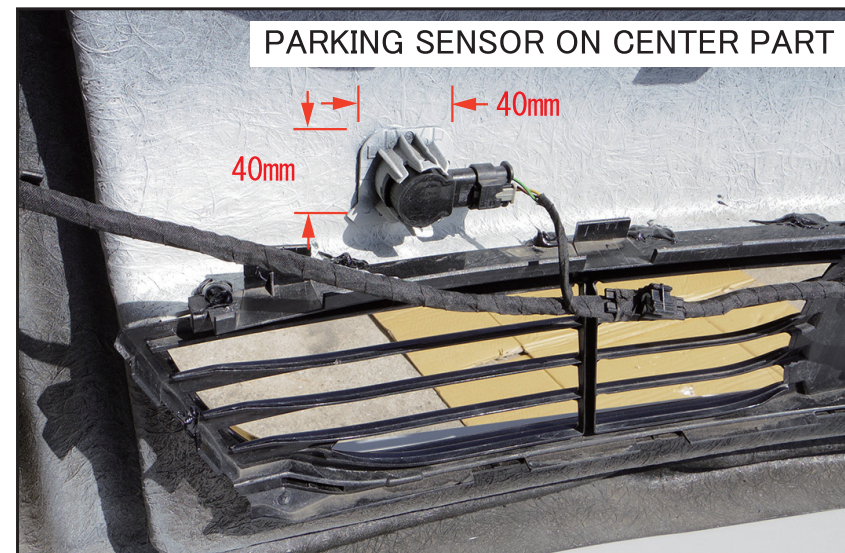
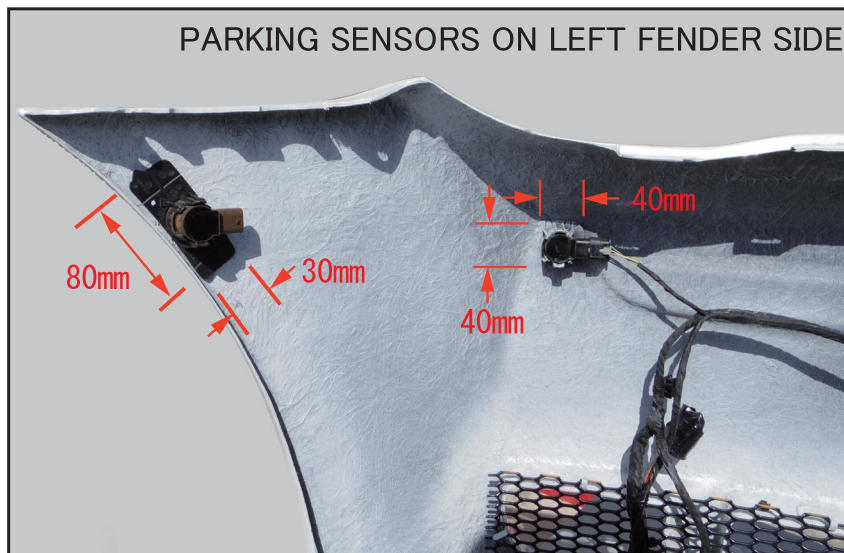

Replace the OEM Parking Sensors after modifying the shape of the basements to fit the holes on WALD Front Bumper.
Be careful of the angle and direction for the replacing.

HOW TO REPLACE THE PARKING SENSORS

※ Fix the Parking Sensors with the same angle and direction of the OEM installation, and must be horizontally with the ground.
If not, it might be the cause of the malfunction.

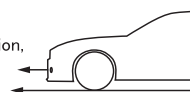

※The shape of the OEM Inner Parts might be different from the Grade/Option of a car. Just modify the shape to fit on WALD Front Bumper for the replacing.

THANK YOU FOR PURCHASING. THIS IS THE INSTALLATION MANUAL OF HOW TO ADJUST OEM INNER PARTS TO FIT WITH WALD FRONT BUMPER FOR BMW G12 7 SERIES. PLEASE READ THIS MANUAL CAREFULLY BEFORE THE INSTALLATION.

HOW TO FIX OEM FRONT INNER PARTS 2

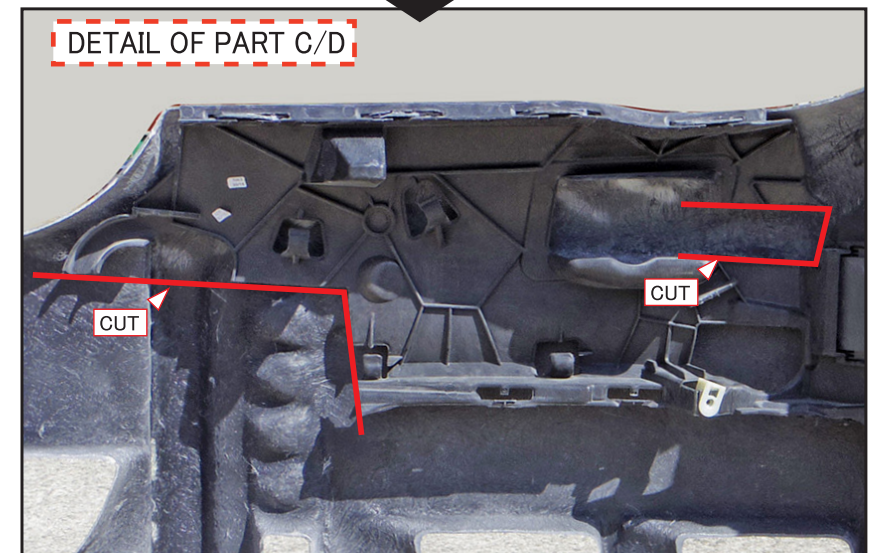
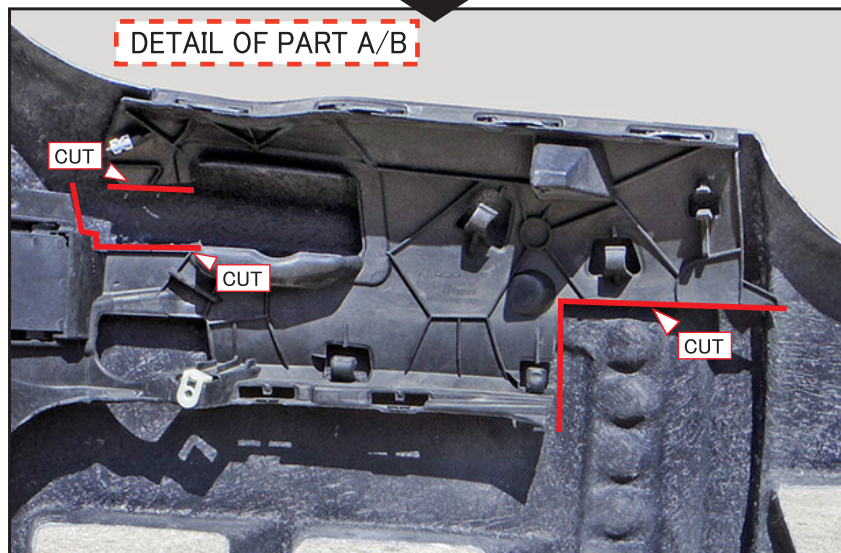
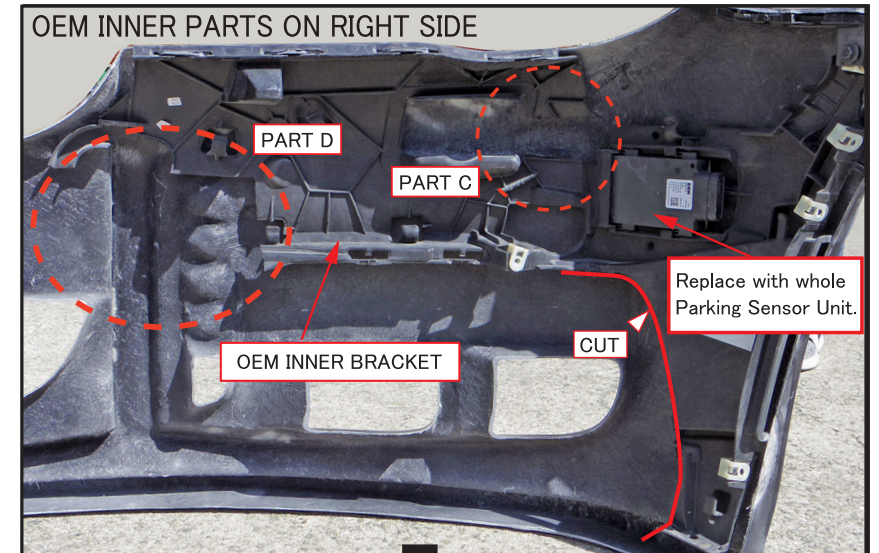
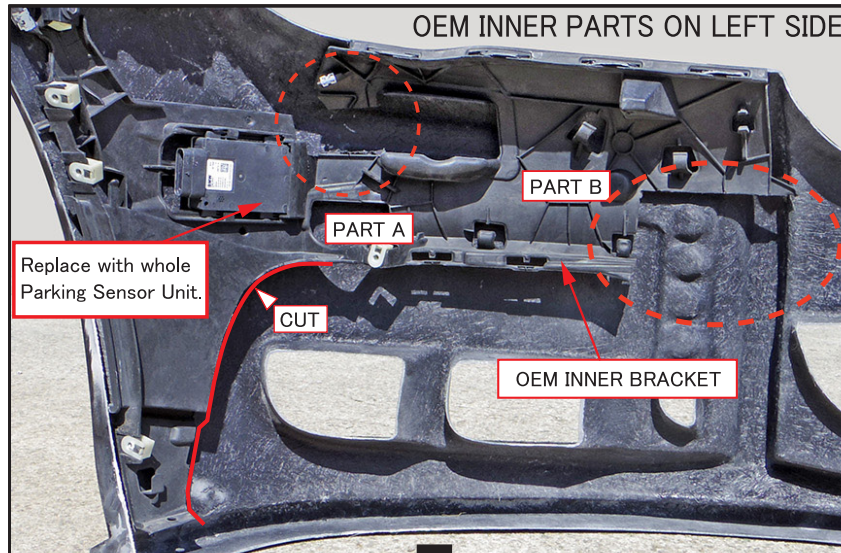
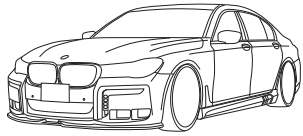

According to the above pictures, cut the OEM Inner Brackets to fit on WALD Front Bumper.

※The shape of the OEM Inner Parts might be different from the Grade/Option of a car. Just modify the shape to fit on WALD Front Bumper for the replacing.

THANK YOU FOR PURCHASING. THIS IS THE INSTALLATION MANUAL OF HOW TO ADJUST OEM INNER PARTS TO FIT WITH WALD FRONT BUMPER FOR BMW G12 7 SERIES.
PLEASE READ THIS MANUAL CAREFULLY BEFORE THE INSTALLATION.

HOW TO FIX OEM FRONT INNER PARTS ③

※Use the Silicon Glue.

HOW TO REPLACE THE PARKING SENSORS

※ Fix the Parking Sensors with the same angle and direction of the OEM installation, and must be horizontally with the ground.
If not, it might be the cause of the malfunction.

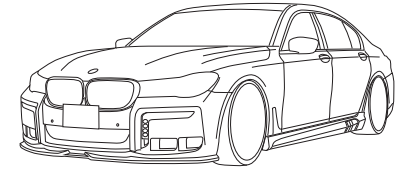
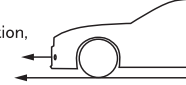

REPLACE THE PARKING SENSOR

Stick the nails into OEM Brackets (8 Points in Total)

Stick the Pins of OEM Brackets into WALD Front Bumper (4 Points in Total)

REPLACE THE PARKING SENSOR

ATTACHED MESH

Use pins and caulking glue to install the attached meshes.

REPLACE OEM LOWER GRILLE

Use the caulking glue to fix tightly.
※Must be installed horizontally with the body.

OEM INNER BRACKET

OEM INNER BRACKET

THANK YOU FOR PURCHASING. THIS IS THE INSTALLATION MANUAL OF WALD SIDE STEPS FOR BMW G12 7 SERIES.
PLEASE READ THIS MANUAL CAREFULLY BEFORE THE INSTALLATION.

ATTENTION



- ※ NO RETURNS CAN BE ACCEPTED BECAUSE OF IMPROPER INSTALLATION OR PAINTING.
- ※ CHECK THE FITMENT, AND ADJUST ALL THE DETAILS BEFORE PAINTING.
- We assume no responsibility for any damage resulting from improper installation, painting, modification and any cut wound in unsealing.
- Contact the car dealer when you have any question in removing OEM parts.
- During all the installation process, use parking brake and stop the engine completely.
- Use rasps or sandpapers to fit the products to the body if there is an individual difference.
- The product is made of FRP. Handle with care. Do not give the excessive force.
- Gradually fix the bolts and nuts by checking the fitment and balance of the installation.
- Check the fitment, and adjust all the details of the fitment steady and proper.
- Please check the fitment and all the details regularly, fix the bolts and nuts as necessary.
- The instruction of painting is just our recommendation, please paint it as you like.
- ※ PLEASE BE AWARE OF:
- You may lose the warranty and all the services from the car maker, because of replacing OEM parts.
- Reduced road clearance may cause inconvenience in using parking curbs and garage jack.
- FRP, ABS and PPE products are slightly weaker than OEM parts in crashes.
- The product may not match the body and OEM color perfectly.

Please purchase double sided tape, primer and caulking glue at auto accessory shop or hardware store.

Completely degrease and paint primer on all the installation positions to enhance the viscosity of double sided tape.
Use dryer to warm double sided tape to enhance the viscosity in low temperature.
Keep the car in a dry condition more than 24 hours after gluing.
Do not wash the car during this time.

SIDE STEPS	PARTS		QUANTITIES
		SIDE STEPS	TAPPING SCREWS (M4 x 16)

Use caulking glue to fill the gap between the product and the body.

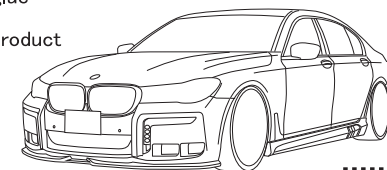

SIDE STEP

[BEFORE PAINTING]

- 1) Temporarily install WALD Side Steps to the body.
- ※ Adjust the details of WALD Side Steps to fit the body by rasps or sandpapers.
- 2) Mark the location of the holes for the attached tapping screws after checking the balance, then make the holes according to the marked positions.
- 3) For the Car equipped the OEM LED Lamps, according to PIC1/2, Cut Out the OEM LED Lamps from the OEM Rocker Panels (PIC 1). Make the holes according to the Cut-Lines on WALD Sidesteps (PIC 2).
- 4) For the Car equipped the OEM LED Lamps, replace the whole OEM LED Brackets to WALD Sidesteps with the caulking glue.
- 5) Check the fitting on the body.
- 6) Paint WALD Side Steps according to the picture.

[AFTER PAINTING]

- 7) Completely degrease the installation positions, then use caulking glue to install WALD Side Steps to the body.
- ※ Fold the both ends of release paper to adjust the location of using double sided tape.
- 8) Check all the details of the fitment.
- 9) Use masking tape to fix WALD Side Steps to the body, then leave them till completely fixed.

※WALD SHOWCAR IS PAINTED LIKE THE PICTURE (STEP 6)

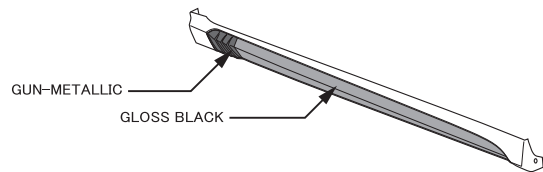

ATTENTION

- ※ MORE THAN 2 TECHNICIANS ARE NECESSARY IN THIS WORK.
- ※ DURING ALL THE INSTALLATION PROCESS, PLEASE BE CAREFUL NOT TO DAMAGE THE BODY.
- ※ DEGREASE ALL THE INSTALLATION POSITIONS, AND REMOVE THE BODY PROTECTION COATING BEFORE THE INSTALLATION.
- ※ ADJUST ALL THE DETAILS OF OUR PRODUCTS TO FIT ON A CAR PERFECTLY.

PIC 1
HOW TO CUT OEM ROCKER PANELS (STEP 3)
(Only for a Car equipped OEM LED LAMPS)

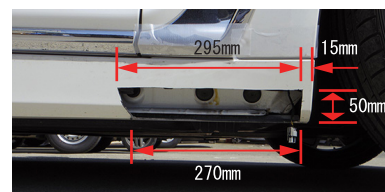

PIC 2
HOW TO CUT WALD SIDESTEPS (STEP 3)
(Only for a Car equipped OEM LED LAMPS)

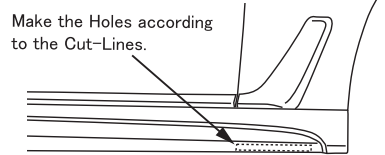

PIC 3
HOW TO REPLACE OEM LED LAMPS
(Only for a Car equipped OEM LED LAMPS)

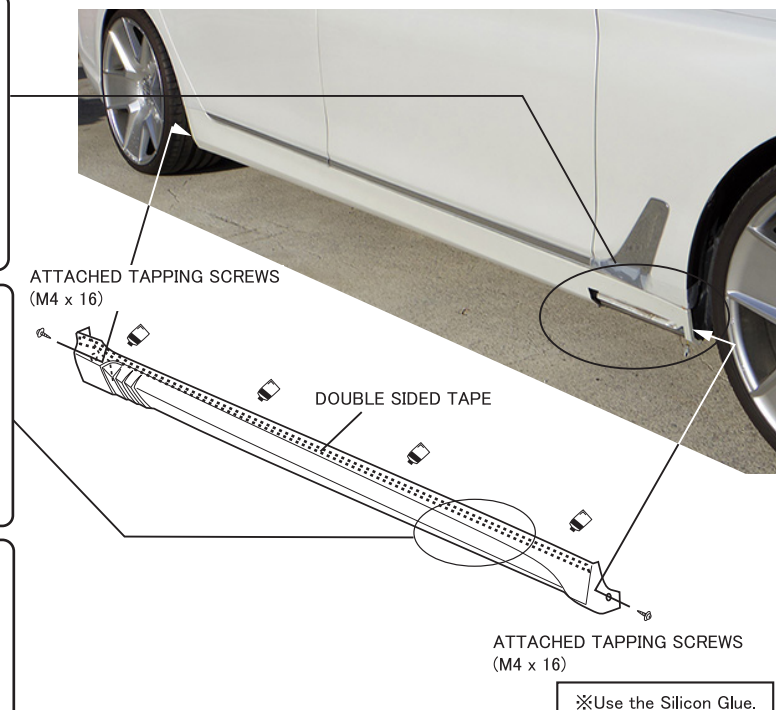

※Use the Silicon Glue.

THANK YOU FOR PURCHASING. THIS IS THE INSTALLATION MANUAL OF WALD REAR BUMPER FOR BMW G12 7 SERIES.
PLEASE READ THIS MANUAL CAREFULLY BEFORE THE INSTALLATION.

ATTENTION



- ※ NO RETURNS CAN BE ACCEPTED BECAUSE OF IMPROPER INSTALLATION OR PAINTING.
- ※ CHECK THE FITMENT, AND ADJUST ALL THE DETAILS BEFORE PAINTING.
- We assume no responsibility for any damage resulting from improper installation, painting, modification and any cut wound in unsealing.
- Contact the car dealer when you have any question in removing OEM parts.
- During all the installation process, use parking brake and stop the engine completely.
- Use rasps or sandpapers to fit the products to the body if there is an individual difference.
- The product is made of FRP. Handle with care. Do not give the excessive force. Gradually fix the bolts and nuts by checking the fitment and balance of the installation.
- Check the fitment, and adjust all the details of the fitment steady and proper. Please check the fitment and all the details regularly, fix the bolts and nuts as necessary.
- The instruction of painting is just our recommendation, please paint it as you like.
- ※ PLEASE BE AWARE OF:
 - You may lose the warranty and all the services from the car maker, because of replacing OEM parts.
 - Reduced road clearance may cause inconvenience in using parking curbs and garage jack.
 - FRP, ABS and PPE products are slightly weaker than OEM parts in crashes.
 - The product may not match the body and OEM color perfectly.

Please purchase double sided tape, primer and caulking glue at auto accessory shop or hardware store.

Completely degrease and paint primer on all the installation positions to enhance the viscosity of double sided tape.

Use dryer to warm double sided tape to enhance the viscosity in low temperature.
Keep the car in a dry condition more than 24 hours after gluing.
Do not wash the car during this time.

	PARTS	QUANTITIES
FRONT BUMPER	REAR BUMPER	1
	LED LAMP WITH NUTS	1
	SMOOTHING PANEL	1
	TOW HOOK COVER	1
OPTION PARTS	MUFFLER CUTTER	1 SET

Use caulking glue to fill the gap between the product and the body.

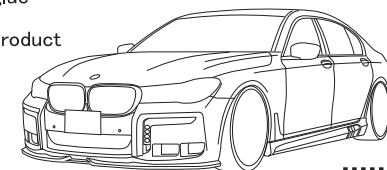

REAR BUMPER

[BEFORE PAINTING]

- 1) Remove OEM rear bumper according to the BMW service manual.
- 2) Take off OEM energy absorber and muffler cutters from the body.
- 3) Replace OEM inner parts to WALD Rear Bumper, then temporarily install WALD Rear Bumper to the body. (As per enclosures)
- 4) Prepare to connect the attached LED lamp.
 - ※ Insulate any spare harness.
- 5) Check the fitting and balance on the body.
- 6) Paint WALD Rear Bumper according to the picture.

[AFTER PAINTING]

- 7) Relocate all the necessary parts to WALD Rear Bumper, then temporarily install to the body (As per enclosures).
- 8) Fix the attached LED lamp and OEM reflectors on WALD Rear Bumper.
 - ※ Make sure the attached LED lamp kit is fine to work before the installation.
 - ※ Use the attached LED lamp as the Rear Fog Lamp.
- 9) Temporarily install WALD Rear Bumper to the body.
- 10) Check all the details of the fitment, then fix the OEM tapping screws tightly.
- 11) Use the double sided tape to fix the attached Tow Hook Cover on WALD Rear Bumper.

※Use the Silicon Glue.

※ WALD SHOWCAR IS PAINTED LIKE THE PICTURE (STEP 6)

GLOSS BLACK

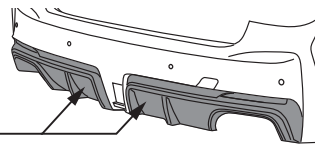

ATTACHED LED LAMP
※Use the attached LED Lamp as the Rear Fog Lamp Function (STEP 4 & 8).

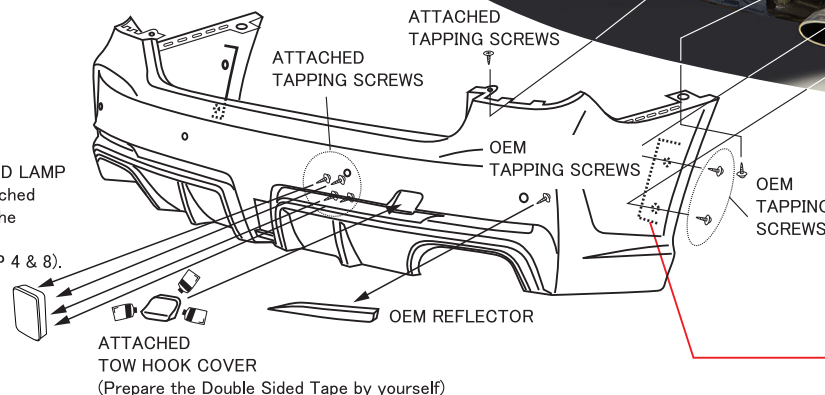

Sandwich WALD Rear Bumper between Inner Flange and Inner Liner (Cover).

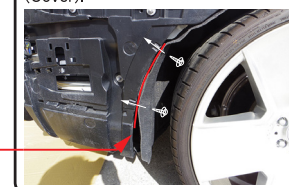

ATTENTION

- ※ MORE THAN 2 TECHNICIANS ARE NECESSARY IN THIS WORK. DURING ALL THE INSTALLATION PROCESS, PLEASE BE CAREFUL NOT TO DAMAGE THE BODY.
- ※ DEGREASE ALL THE INSTALLATION POSITIONS, AND REMOVE THE BODY PROTECTION COATING BEFORE THE INSTALLATION.
- ※ ADJUST ALL THE DETAILS OF OUR PRODUCTS TO FIT ON A CAR PERFECTLY.

THANK YOU FOR PURCHASING. THIS IS THE INSTALLATION MANUAL OF HOW TO REPLACE OEM INNER PARTS OF BMW G12 7 SERIES.
PLEASE READ THIS MANUAL CAREFULLY BEFORE THE INSTALLATION.

HOW TO FIX OEM REAR INNER PARTS

※Use the Silicon Glue.

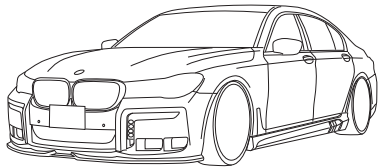

STEP① LEFT SIDE OF WALD REAR BUMPER. HOW TO RELOCATE PTS.

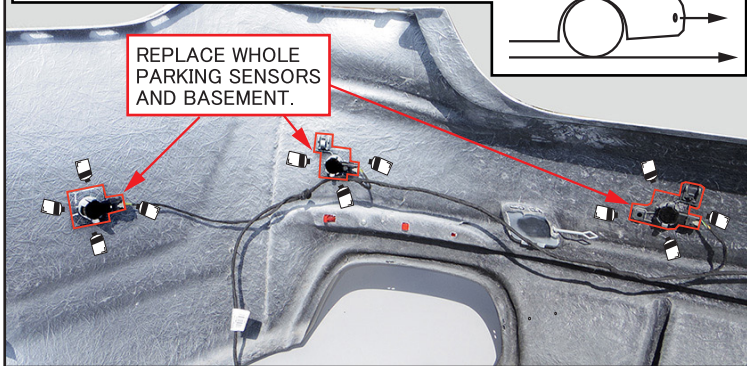
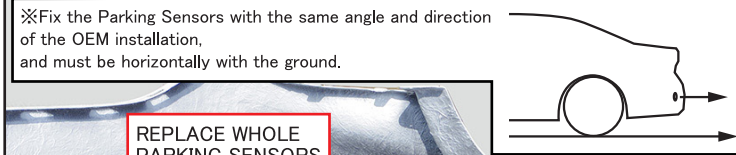

According to the picture, replace the OEM parking sensors and basement to the holes on WALD Rear Bumper.
※The shape of the OEM Inner Parts might be different from the Grade/Option of a car. Just modify the shape to fit on WALD Rear Bumper for the replacing.

STEP② HOW TO MODIFY OEM REAR INNER PART

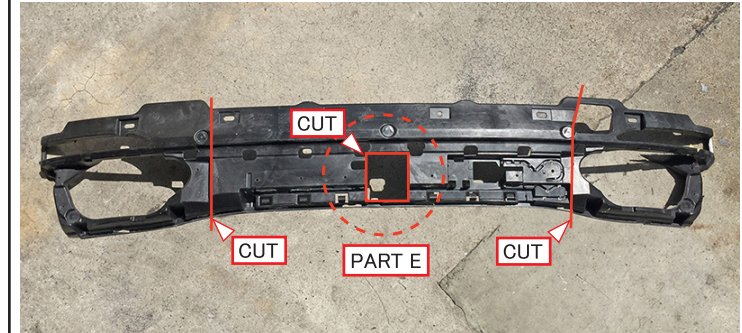

Cut OEM Inner Part according to the Cut Lines on the above picture to fit on WALD Rear Bumper.
※The shape of the OEM Inner Parts might be different from the Grade/Option of a car. Just modify the shape to fit on WALD Rear Bumper for the replacing.

STEP④ HOW TO FIX OEM REAR INNER PART

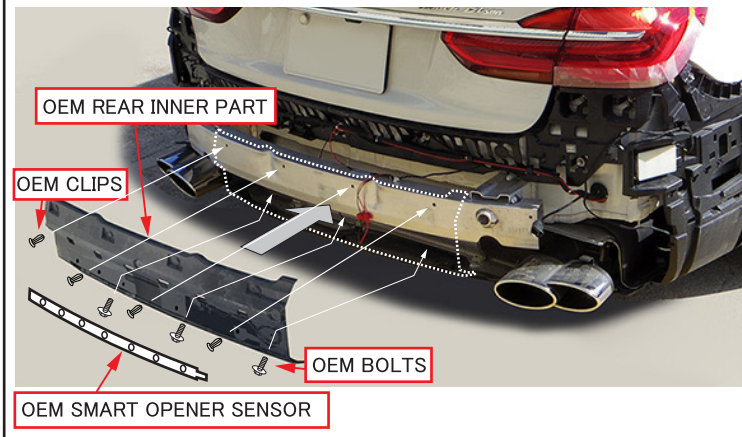

Replace OEM Inner Part after modifying based on STEP 2 & 3.
Make sure OEM Smart Opener Sensor is fine to work before the installation.
※The shape of the OEM Inner Parts might be different from the Grade/Option of a car. Just modify the shape to fit on WALD Rear Bumper for the replacing.

STEP③ ENLARGED PICTURE OF "E" ON STEP 2

