

# ROLLS-ROYCE PHANTOM Drophead

WALD SPORTS LINE  
BLACK BISON EDITION

INSTALLATION MANUAL  
**WALD**  
Sportliche Autoausrüstung WALD.International

THANK YOU FOR PURCHASING. THIS IS THE INSTALLATION MANUAL OF WALD FRONT BUMPER FOR ROLLS-ROYCE PHANTOM DROPHEAD.  
PLEASE READ THIS MANUAL CAREFULLY BEFORE THE INSTALLATION.

## ATTENTION



- ※ NO RETURNS CAN BE ACCEPTED BECAUSE OF IMPROPER INSTALLATION OR PAINTING.
- ※ CHECK THE FITMENT, AND ADJUST ALL THE DETAILS BEFORE PAINTING.
- We assume no responsibility for any damage resulting from improper installation, painting, modification and any cut wound in unsealing.
- Contact the car dealer when you have any question in removing OEM parts.
- During all the installation process, use parking brake and stop the engine completely.
- Use rasps or sandpapers to fit the products to the body if there is an individual difference.
- The product is made of FRP. Handle with care. Do not give the excessive force.
- Gradually fix the bolts and nuts by checking the fitment and balance of the installation.
- Check the fitment, and adjust all the details of the fitment steady and proper.
- Please check the fitment and all the details regularly, fix the bolts and nuts as necessary.
- The instruction of painting is just our recommendation, please paint it as you like.
- ※ PLEASE BE AWARE OF:
  - You may lose the warranty and all the services from the car maker, because of replacing OEM parts.
  - Reduced road clearance may cause inconvenience in using parking curbs and garage jack.
  - FRP, ABS and PPE products are slightly weaker than OEM parts in crashes.
  - The product may not match the body and OEM color perfectly.

Please purchase double sided tape, primer and caulking glue at auto accessory shop or hardware store.

Completely degrease and paint primer on all the installation positions to enhance the viscosity of double sided tape.  
Use dryer to warm double sided tape to enhance the viscosity in low temperature.  
Keep the car in a dry condition more than 24 hours after gluing.  
Do not wash the car during this time.

	PARTS	QUANTITIES
FRONT BUMPER	FRONT BUMPER	1
	TOW HOOK COVER	1
	STAINLESS MESHES	1 SET
	ALUMINIUM MESHES	1 SET
	LED LAMP KIT	1 SET

Use caulking glue to fill the gap between the product and the body.

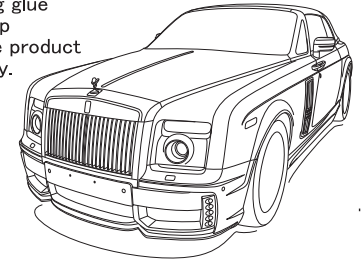

## FRONT BUMPER

### [BEFORE PAINTING]

- 1) Remove OEM front bumper according to the Rolls-Royce service manual.
- 2) Process OEM intake ducts according to the picture to install WALD Front Bumper.
- 3) Temporarily install WALD Front Bumper to the body.
- ※ Adjust the details of WALD Front Bumper to fit the body by rasps or sandpapers.
- 4) Paint WALD Front Bumper according to the picture.

### [AFTER PAINTING]

- 5) Install PTS and the attached LED lamp kit to WALD Front Bumper.
- ※ Make sure the attached LED lamp kit is fine to work before the installation.
- 6) Use caulking glue to relocate OEM front camera to WALD Front Bumper.
- Check the angle of OEM front camera by watching car monitor.
- ※ Make a cut on the attached meshes to install harness.
- 7) Install the attached tow hook cover, then use caulking glue to install the attached meshes (Two-Ply) to WALD Front Bumper from the rear.
- 8) Temporarily tighten OEM bolts and tapping screws to install WALD Front Bumper to the body.
- 9) Check all the details of the fitment, then fix them.
- 10) Relocate OEM headlight washer covers to WALD Front Bumper.
- ※ Adjust the details of WALD Front Bumper to fit OEM headlight washer covers by rasps or sandpapers.

## ATTENTION

- ※ MORE THAN 2 TECHNICIANS ARE NECESSARY IN THIS WORK. DURING ALL THE INSTALLATION PROCESS, PLEASE BE CAREFUL NOT TO DAMAGE THE BODY.
- ※ DEGREASE ALL THE INSTALLATION POSITIONS, AND REMOVE THE BODY PROTECTION COATING BEFORE THE INSTALLATION.
- ※ ADJUST ALL THE DETAILS OF THE FITMENT.

※ WALD SHOWCAR IS PAINTED LIKE THE PICTURE (STEP 4)

■ LOCATION OF THE ATTACHED MESHES (STEP 7)

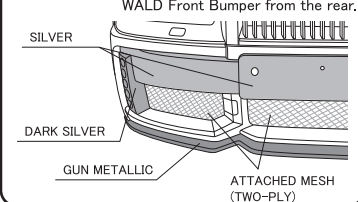

■ HOW TO PROCESS OEM INTAKE DUCTS (STEP 2)

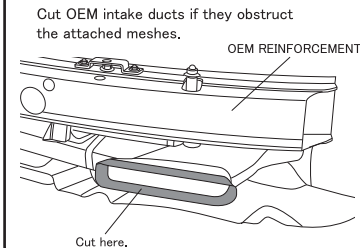

■ HOW TO INSTALL THE ATTACHED MESHES (STEP 7)

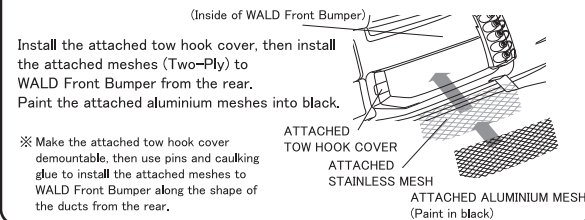

■ HOW TO INSTALL PTS (STEP 5)

Remove PTS and bases, then use caulking glue to fix them to WALD Front Bumper from the rear.

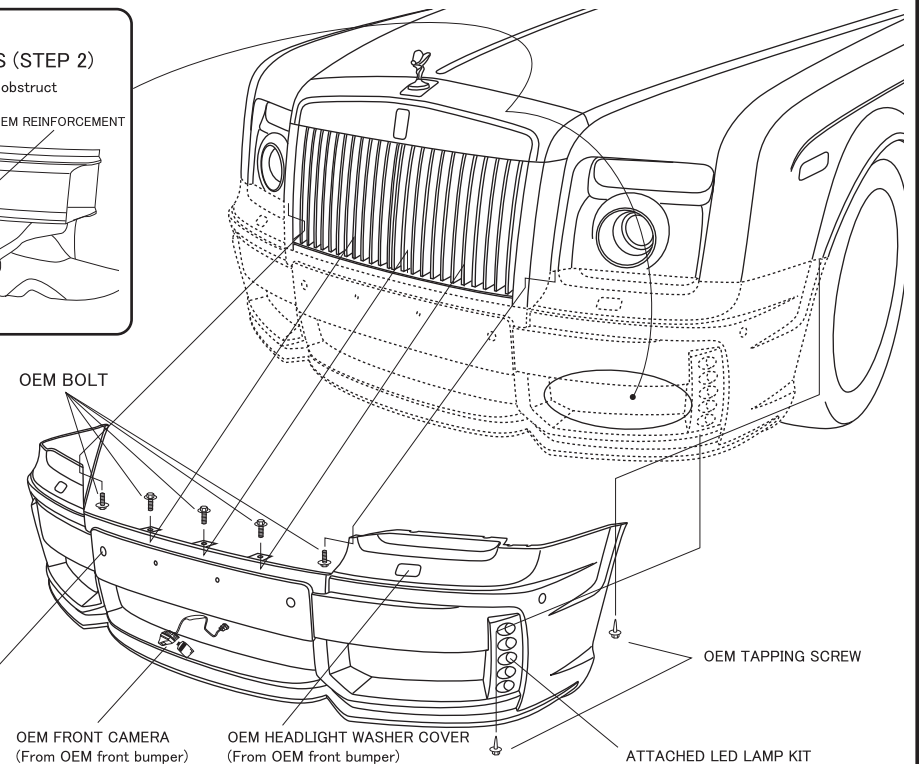

# ROLLS-ROYCE PHANTOM Drophead

WALD SPORTS LINE  
BLACK BISON EDITION

INSTALLATION MANUAL  
**WALD**  
Sportliche Autoausrüstung WALD.International

THANK YOU FOR PURCHASING. THIS IS THE INSTALLATION MANUAL OF WALD SIDE STEPS FOR ROLLS-ROYCE PHANTOM DROPHEAD.  
PLEASE READ THIS MANUAL CAREFULLY BEFORE THE INSTALLATION.

## ATTENTION



- ※ NO RETURNS CAN BE ACCEPTED BECAUSE OF IMPROPER INSTALLATION OR PAINTING.
- ※ CHECK THE FITMENT, AND ADJUST ALL THE DETAILS BEFORE PAINTING.
- We assume no responsibility for any damage resulting from improper installation, painting, modification and any cut wound in unsealing.
- Contact the car dealer when you have any question in removing OEM parts.
- During all the installation process, use parking brake and stop the engine completely.
- Use rasps or sandpapers to fit the products to the body if there is an individual difference.
- The product is made of FRP. Handle with care. Do not give the excessive force.
- Gradually fix the bolts and nuts by checking the fitment and balance of the installation.
- Check the fitment, and adjust all the details of the fitment steady and proper.
- Please check the fitment and all the details regularly, fix the bolts and nuts as necessary.
- The instruction of painting is just our recommendation, please paint it as you like.
- ※ PLEASE BE AWARE OF:
  - You may lose the warranty and all the services from the car maker, because of replacing OEM parts.
  - Reduced road clearance may cause inconvenience in using parking curbs and garage jack.
  - FRP, ABS and PPE products are slightly weaker than OEM parts in crashes.
  - The product may not match the body and OEM color perfectly.

Please purchase double sided tape, primer and caulking glue at auto accessory shop or hardware store.

Completely degrease and paint primer on all the installation positions to enhance the viscosity of double sided tape.  
Use dryer to warm double sided tape to enhance the viscosity in low temperature.  
Keep the car in a dry condition more than 24 hours after gluing.  
Do not wash the car during this time.

	PARTS	QUANTITIES
SIDE STEP	SIDE STEPS	1 SET



Use caulking glue to fill the gap between the product and the body.

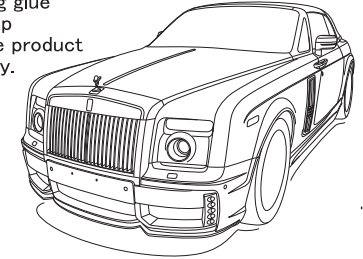

## SIDE STEP

### [BEFORE PAINTING]

- 1) Temporarily install WALD Side Steps to the body.
- ※ Adjust the details of WALD Side Steps to fit the body by rasps or sandpapers.
- 2) Check the fitment, then use masking tape to mark the installation positions.
- 3) Paint WALD Side Steps according to the picture.

### [AFTER PAINTING]

- 4) Completely degrease the installation positions, then use caulking glue to install WALD Side Steps to the body according to the marked positions.
- ※ Some parts of the bottom of WALD Side Steps cannot be fixed because of the shape of OEM side steps.
- 5) Check all the details of the fitment, leave them till completely fixed.

- ※ WALD SHOWCAR IS PAINTED LIKE THE PICTURE (STEP 3)

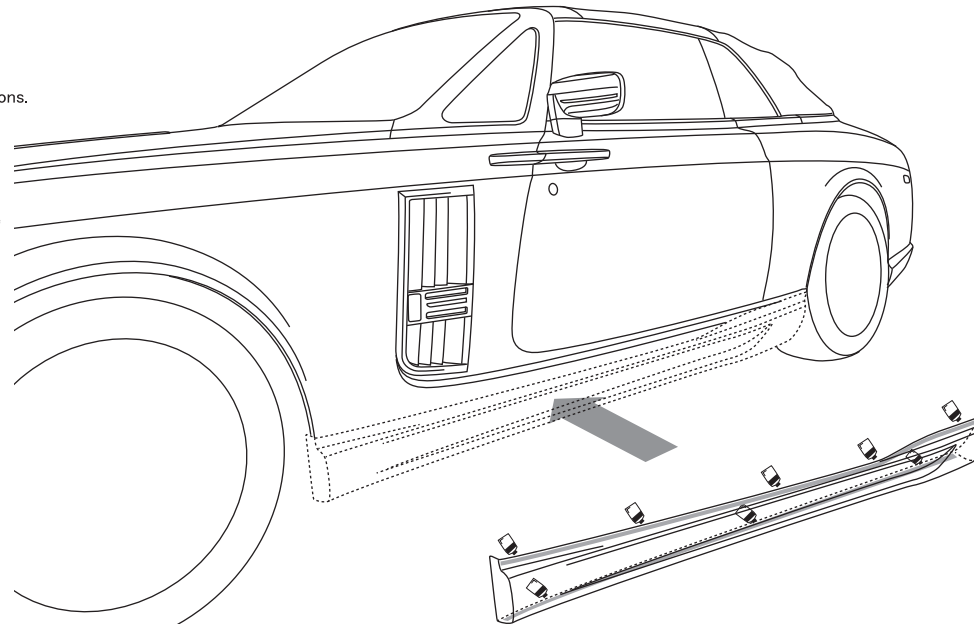
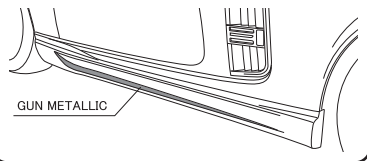

## ATTENTION



- ※ MORE THAN 2 TECHNICIANS ARE NECESSARY IN THIS WORK.
- DURING ALL THE INSTALLATION PROCESS, PLEASE BE CAREFUL NOT TO DAMAGE THE BODY.
- ※ DEGREASE ALL THE INSTALLATION POSITIONS, AND REMOVE THE BODY PROTECTION COATING BEFORE THE INSTALLATION.
- ※ ADJUST ALL THE DETAILS OF THE FITMENT.

After the installation, use silicon glue to cover the gap between WALD Side Steps and the body.

WALD INTERNATIONAL

# ROLLS-ROYCE PHANTOM Drophead

WALD SPORTS LINE  
BLACK BISON EDITION

INSTALLATION MANUAL  
**WALD**  
Sportliche Autoausrüstung WALD.International

THANK YOU FOR PURCHASING. THIS IS THE INSTALLATION MANUAL OF WALD REAR BUMPER FOR ROLLS-ROYCE PHANTOM DROPHEAD.  
PLEASE READ THIS MANUAL CAREFULLY BEFORE THE INSTALLATION.

## ATTENTION



- ※ NO RETURNS CAN BE ACCEPTED BECAUSE OF IMPROPER INSTALLATION OR PAINTING.
- ※ CHECK THE FITMENT, AND ADJUST ALL THE DETAILS BEFORE PAINTING.
- We assume no responsibility for any damage resulting from improper installation, painting, modification and any cut wound in unsealing.
- Contact the car dealer when you have any question in removing OEM parts.
- During all the installation process, use parking brake and stop the engine completely.
- Use rasps or sandpapers to fit the products to the body if there is an individual difference.
- The product is made of FRP. Handle with care. Do not give the excessive force. Gradually fix the bolts and nuts by checking the fitment and balance of the installation.
- Check the fitment, and adjust all the details of the fitment steady and proper. Please check the fitment and all the details regularly, fix the bolts and nuts as necessary.
- The instruction of painting is just our recommendation, please paint it as you like.
- ※ PLEASE BE AWARE OF:
  - You may lose the warranty and all the services from the car maker, because of replacing OEM parts.
  - Reduced road clearance may cause inconvenience in using parking curbs and garage jack.
  - FRP, ABS and PPE products are slightly weaker than OEM parts in crashes.
  - The product may not match the body and OEM color perfectly.

Please purchase double sided tape, primer and caulking glue at auto accessory shop or hardware store.

Completely degrease and paint primer on all the installation positions to enhance the viscosity of double sided tape.

Use dryer to warm double sided tape to enhance the viscosity in low temperature.  
Keep the car in a dry condition more than 24 hours after gluing.  
Do not wash the car during this time.

	PARTS	QUANTITIES
REAR BUMPER	REAR BUMPER	1
	STAINLESS MESHES	1 SET
	ALUMINIUM MESHES	1 SET
	LED LAMP (WITH FIXING NUTS)	1
	EXHAUST FINISHERS	1 SET
	BOLTS (M5 x 15) & NUTS	2 SETS
	MUFFLER ADAPTERS	4

Use caulking glue to fill the gap between the product and the body.

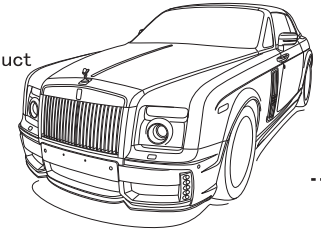

## REAR BUMPER

### 【BEFORE PAINTING】

- 1) Remove OEM rear bumper according to the Rolls-Royce service manual.
- 2) Relocate OEM pins to WALD Rear Bumper from the rear.
- 3) Install the attached muffler adapters, then temporarily install WALD Rear Bumper to the body.
- ※ Adjust the details of WALD Rear Bumper to fit the body by rasps or sandpapers.
- 4) Paint WALD Rear Bumper according to the picture.

### 【AFTER PAINTING】

- 5) Install PTS, attached LED lamp and exhaust finishers to WALD Rear Bumper.
- ※ Make sure the attached LED lamp is fine to work before the installation.
- 6) Use caulking glue to install the attached meshes to WALD Rear Bumper from the rear.
- 7) Temporarily fix the attached bolts and nuts to install WALD Rear Bumper to the body.
- 8) Check all the details of the fitment, then fix all the bolts and nuts.
- 9) Use caulking glue to fix OEM rear bumper sill protectors to WALD Rear Bumper.

■ HOW TO INSTALL THE ATTACHED MUFFLER ADAPTERS (STEP 3)

Use the attached bolts to install the attached muffler adapters.

ATTACHED MUFFLER ADAPTER

※ Make the attached muffler adapter outlets lower than the bottom of WALD Rear Bumper.

■ HOW TO INSTALL THE ATTACHED LED LAMP (STEP 5)

ATTACHED NUT (M5)  
ATTACHED LED LAMP  
(Inside of WALD Rear Bumper)

■ HOW TO INSTALL THE ATTACHED MESHES (STEP 6)

Use pins and caulking glue to install the attached meshes (Two-Ply) to WALD Rear Bumper along the shape of ducts from the rear. Paint the attached aluminium meshes into black.

(Inside of WALD Rear Bumper)

ATTACHED ALUMINIUM MESH (Paint in black)  
ATTACHED STAINLESS MESH

■ HOW TO INSTALL PTS (STEP 5)

Remove PTS and bases, then use caulking glue to fix them to WALD Rear Bumper from the rear.

ATTACHED LED LAMP  
OEM BOLT  
ATTACHED EXHAUST FINISHER

OEM REAR BUMPER SILL PROTECTOR

OEM BOLT

ATTACHED NUT (M5)

ATTACHED LED LAMP

OEM BOLT

ATTACHED EXHAUST FINISHER

ATTACHED BOLT (M5 x 15)

Relocate OEM pins to WALD Rear Bumper from the rear. (STEP 2)

OEM PIN

(Inside of WALD Rear Bumper)

## ATTENTION



- ※ MORE THAN 2 TECHNICIANS ARE NECESSARY IN THIS WORK. DURING ALL THE INSTALLATION PROCESS, PLEASE BE CAREFUL NOT TO DAMAGE THE BODY.
- ※ DEGREASE ALL THE INSTALLATION POSITIONS, AND REMOVE THE BODY PROTECTION COATING BEFORE THE INSTALLATION.
- ※ ADJUST ALL THE DETAILS OF THE FITMENT.

※ WALD SHOWCAR IS PAINTED LIKE THE PICTURE (STEP 4)

■ LOCATION OF THE ATTACHED MESHES (STEP 6)

Install the attached meshes to WALD Rear Bumper from the rear.

ATTACHED MESH  
GUN METALLIC  
ATTACHED MESH (TWO-PLY)

# ROLLS-ROYCE PHANTOM Drophead

WALD SPORTS LINE  
BLACK BISON EDITION

INSTALLATION MANUAL  
**WALD**  
Sportliche Autoausrüstung WALD.International

THANK YOU FOR PURCHASING. THIS IS THE INSTALLATION MANUAL OF WALD FENDER PANELS FOR ROLLS-ROYCE PHANTOM DROPHEAD.  
PLEASE READ THIS MANUAL CAREFULLY BEFORE THE INSTALLATION.

## ATTENTION



- ※ NO RETURNS CAN BE ACCEPTED BECAUSE OF IMPROPER INSTALLATION OR PAINTING.
- ※ CHECK THE FITMENT, AND ADJUST ALL THE DETAILS BEFORE PAINTING.
- We assume no responsibility for any damage resulting from improper installation, painting, modification and any cut wound in unsealing.
- Contact the car dealer when you have any question in removing OEM parts.
- During all the installation process, use parking brake and stop the engine completely.
- Use rasps or sandpapers to fit the products to the body if there is an individual difference.
- The product is made of FRP. Handle with care. Do not give the excessive force. Gradually fix the bolts and nuts by checking the fitment and balance of the installation.
- Check the fitment, and adjust all the details of the fitment steady and proper. Please check the fitment and all the details regularly, fix the bolts and nuts as necessary.
- The instruction of painting is just our recommendation, please paint it as you like.
- ※ PLEASE BE AWARE OF:
- You may lose the warranty and all the services from the car maker, because of replacing OEM parts.
- Reduced road clearance may cause inconvenience in using parking curbs and garage jack.
- FRP, ABS and PPE products are slightly weaker than OEM parts in crashes.
- The product may not match the body and OEM color perfectly.

Please purchase double sided tape, primer and caulking glue at auto accessory shop or hardware store.

Completely degrease and paint primer on all the installation positions to enhance the viscosity of double sided tape.  
Use dryer to warm double sided tape to enhance the viscosity in low temperature.  
Keep the car in a dry condition more than 24 hours after gluing.  
Do not wash the car during this time.

	PARTS	QUANTITIES
FENDER PANEL	FENDER PANELS	1 SET
	WINKER LAMPS	1 SET
	MESHES	1 SET
	STAINLESS UPPER PANELS	1 SET
	STAINLESS UNDER PANELS	1 SET

 Use caulking glue to fill the gap between the product and the body.

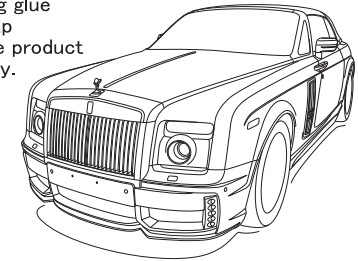

## FENDER PANEL

### [BEFORE PAINTING]

- 1) See attachment to cut OEM front fenders. Temporarily install WALD Fender Panels to the body.
  - 2) Make use of the harness of OEM winker lamp to prepare to connect the attached winker lamps.
- ※ Make sure the attached winker lamps are fine to work before the installation.  
The warning lamp will show if the attached winker lamps are installed incorrectly.
- 3) Paint WALD Fender Panels according to the picture.

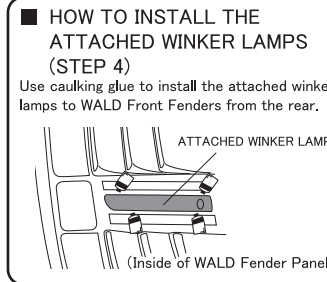
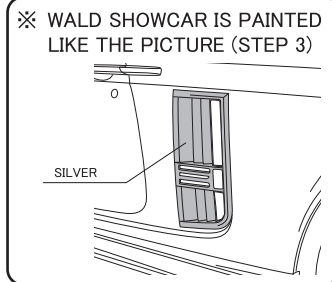

### [AFTER PAINTING]

- 4) Use caulking glue to install the attached winker lamps and meshes to WALD Fender Panels from the rear.
- 5) Completely degrease the installation positions, then use caulking glue to install WALD Fender Panels to the body.
- 6) Check all the details of the fitment, leave them till completely fixed.

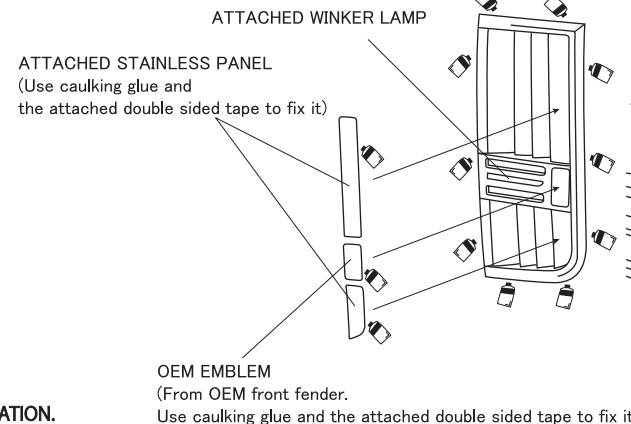
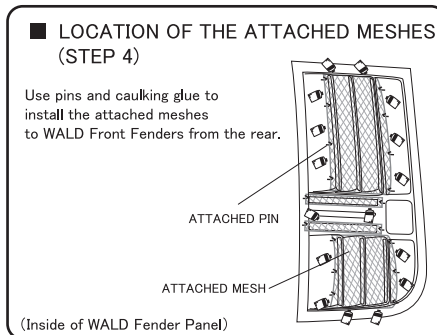

After the installation, use silicon glue to cover the gap between WALD Fender Panels and the body.

## ATTENTION



- ※ DURING ALL THE INSTALLATION PROCESS, PLEASE BE CAREFUL NOT TO DAMAGE THE BODY.
- ※ DEGREASE ALL THE INSTALLATION POSITIONS, AND REMOVE THE BODY PROTECTION COATING BEFORE THE INSTALLATION.
- ※ ADJUST ALL THE DETAILS OF THE FITMENT.

## FENDER CUT

 CUT HERE

CUTTING LINE MEASUREMENT			
A	235	I	366
B	205	J	225
C	53	K	470
D	173	L	243
E	15	M	327
F	167	N	380
G	18	O	38
H	387	P	447

(mm)

※ Check the cutting line measurement, then use masking tape to mark the cutting lines.

※ The instruction of cutting line measurement is just our recommendation. Cut it by checking the fitment.

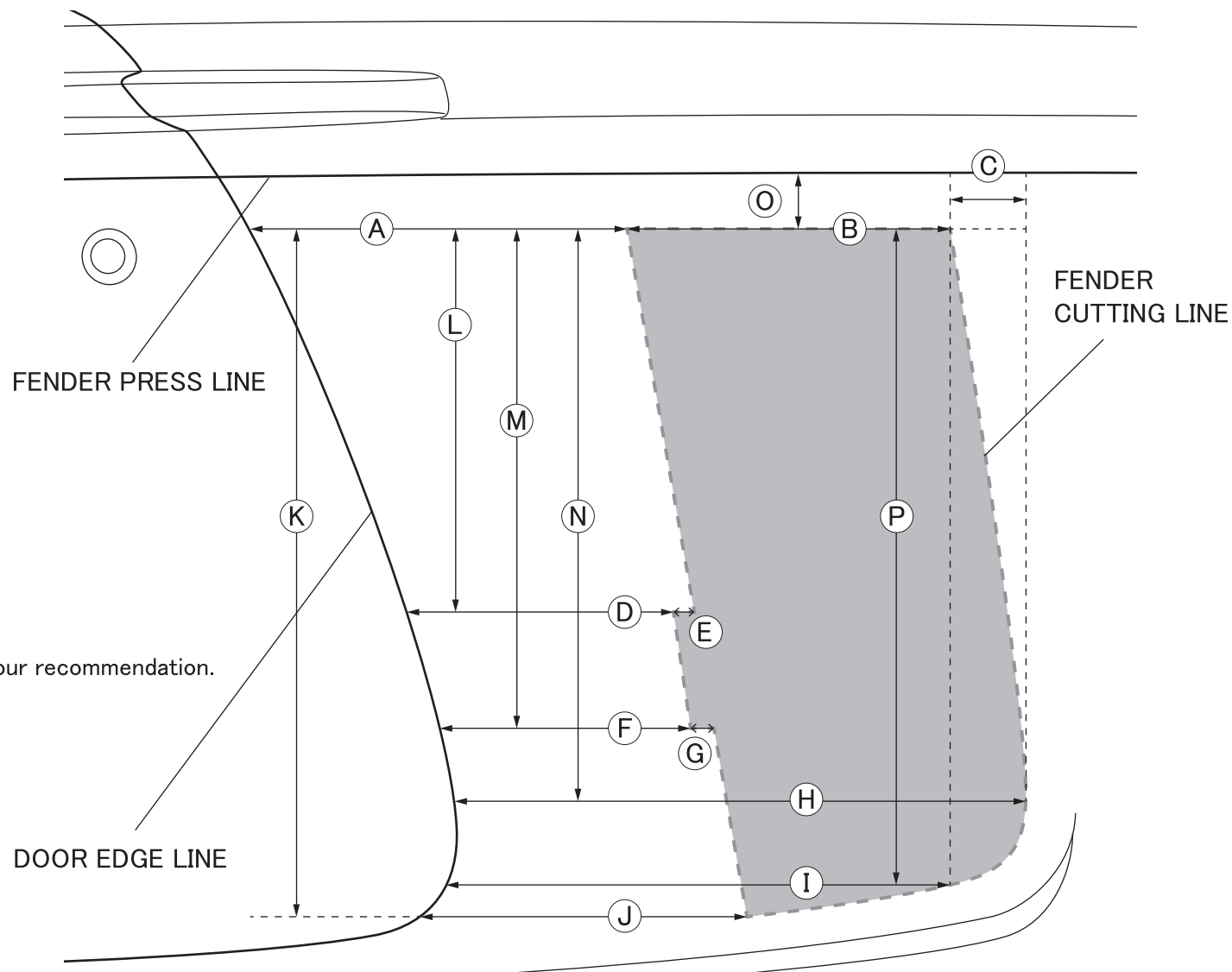

### ATTENTION



※ DURING ALL THE INSTALLATION PROCESS, PLEASE BE CAREFUL NOT TO DAMAGE THE BODY.  
※ ADJUST ALL THE DETAILS OF THE FITMENT.

The picture shows the cutting measure of the right side fender. Be careful to handle the left side.

# ROLLS-ROYCE PHANTOM Drophead

WALD SPORTS LINE  
BLACK BISON EDITION

INSTALLATION MANUAL  
**WALD**  
Sportliche Autoausrüstung WALD.International

THANK YOU FOR PURCHASING. THIS IS THE INSTALLATION MANUAL OF WALD MIRROR COVERS FOR ROLLS-ROYCE PHANTOM DROPHEAD.  
PLEASE READ THIS MANUAL CAREFULLY BEFORE THE INSTALLATION.

## ATTENTION



- ※ NO RETURNS CAN BE ACCEPTED BECAUSE OF IMPROPER INSTALLATION OR PAINTING.
- ※ CHECK THE FITMENT, AND ADJUST ALL THE DETAILS BEFORE PAINTING.
- We assume no responsibility for any damage resulting from improper installation, painting, modification and any cut wound in unsealing.
- Contact the car dealer when you have any question in removing OEM parts.
- During all the installation process, use parking brake and stop the engine completely.
- Use rasps or sandpapers to fit the products to the body if there is an individual difference.
- The product is made of FRP. Handle with care. Do not give the excessive force. Gradually fix the bolts and nuts by checking the fitment and balance of the installation.
- Check the fitment, and adjust all the details of the fitment steady and proper. Please check the fitment and all the details regularly, fix the bolts and nuts as necessary.
- The instruction of painting is just our recommendation, please paint it as you like.
- ※ PLEASE BE AWARE OF:
  - You may lose the warranty and all the services from the car maker, because of replacing OEM parts.
  - Reduced road clearance may cause inconvenience in using parking curbs and garage jack.
  - FRP, ABS and PPE products are slightly weaker than OEM parts in crashes.
  - The product may not match the body and OEM color perfectly.

Please purchase double sided tape, primer and caulking glue at auto accessory shop or hardware store.

Completely degrease and paint primer on all the installation positions to enhance the viscosity of double sided tape.  
Use dryer to warm double sided tape to enhance the viscosity in low temperature.  
Keep the car in a dry condition more than 24 hours after gluing.  
Do not wash the car during this time.

	PARTS	QUANTITIES
MIRROR COVER	MIRROR COVERS	1 SET
	LED LAMPS	1 SET



Use caulking glue to fill the gap between the product and the body.

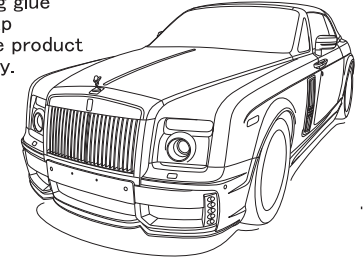

## MIRROR COVER

### [BEFORE PAINTING]

- 1) Remove OEM mirror covers according to the Rolls-Royce service manual.
- 2) Temporarily install WALD Mirror Covers to the body.
- ※ Adjust the details of WALD Mirror Covers to fit the body by rasps or sandpapers.
- 3) Make use of the harness of OEM winker lamps to prepare to connect the attached LED lamps.
- ※ Make sure the attached LED lamps are fine to work before the installation.  
The warning lamp will show if the attached LED lamps are installed incorrectly.
- 4) Paint WALD Mirror Covers according to the picture.

### [AFTER PAINTING]

- 5) Use caulking glue to fix the attached LED lamps to WALD Mirror Covers from the rear.
- 6) Completely degrease the installation positions, then use caulking glue to fix WALD Mirror Covers to the body.
- 7) Check all the details of the fitment, leave them till completely fixed.

After the installation, use silicon glue to cover the gap between WALD Mirror Covers and the body.

### ■ HOW TO INSTALL THE ATTACHED LED LAMPS (STEP 5)

Use caulking glue to fix the attached LED lamps to WALD Mirror Covers from the rear.

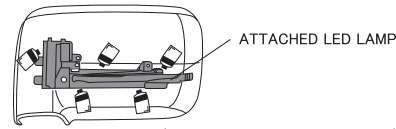

### ※ WALD SHOWCAR IS PAINTED LIKE THE PICTURE (STEP 4)

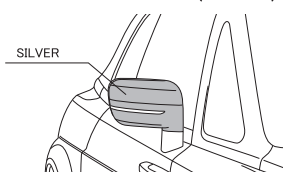

ATTACHED LED LAMP

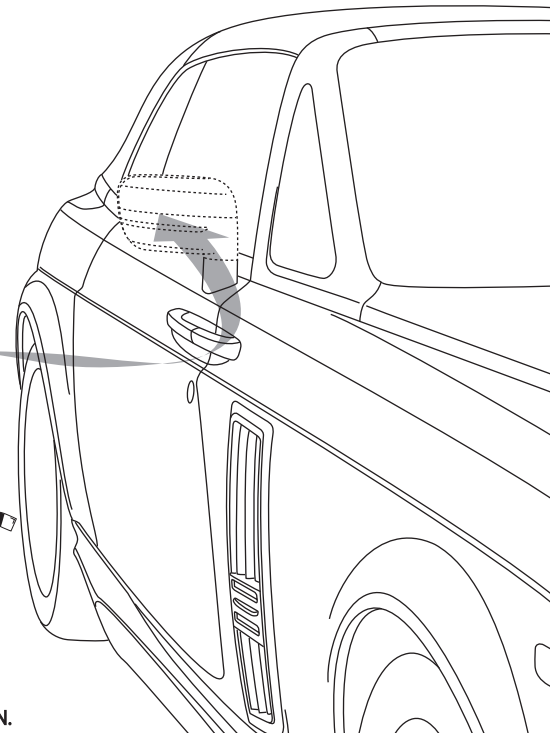

## ATTENTION



- ※ DURING ALL THE INSTALLATION PROCESS, PLEASE BE CAREFUL NOT TO DAMAGE THE BODY.
- ※ DEGREASE ALL THE INSTALLATION POSITIONS, AND REMOVE THE BODY PROTECTION COATING BEFORE THE INSTALLATION.
- ※ ADJUST ALL THE DETAILS OF THE FITMENT.



WALD.INTernational

WALD. INTERNATIONAL

ADD: 10-13 KYOGUCHI-CHO, TAKATSUKI, OSAKA, JAPAN

ZIP: 569-0072

TEL: (81)-72-673-3000

FAX: (81)-72-673-3003

WALD.INTERNATIONAL

# ROLLS-ROYCE PHANTOM Drophead

WALD SPORTS LINE  
BLACK BISON EDITION

INSTALLATION MANUAL  
**WALD**  
Sportliche Autoausrüstung WALD.International

THANK YOU FOR PURCHASING. THIS IS THE INSTALLATION MANUAL OF WALD TRUNK SPOILER FOR ROLLS-ROYCE PHANTOM DROPHEAD.  
PLEASE READ THIS MANUAL CAREFULLY BEFORE THE INSTALLATION.

## ATTENTION



- ※ NO RETURNS CAN BE ACCEPTED BECAUSE OF IMPROPER INSTALLATION OR PAINTING.
- ※ CHECK THE FITMENT, AND ADJUST ALL THE DETAILS BEFORE PAINTING.
- We assume no responsibility for any damage resulting from improper installation, painting, modification and any cut wound in unsealing.
- Contact the car dealer when you have any question in removing OEM parts.
- During all the installation process, use parking brake and stop the engine completely.
- Use rasps or sandpapers to fit the products to the body if there is an individual difference.
- The product is made of FRP. Handle with care. Do not give the excessive force.
- Gradually fix the bolts and nuts by checking the fitment and balance of the installation.
- Check the fitment, and adjust all the details of the fitment steady and proper.
- Please check the fitment and all the details regularly, fix the bolts and nuts as necessary.
- The instruction of painting is just our recommendation, please paint it as you like.
- ※ PLEASE BE AWARE OF:
  - You may lose the warranty and all the services from the car maker, because of replacing OEM parts.
  - Reduced road clearance may cause inconvenience in using parking curbs and garage jack.
  - FRP, ABS and PPE products are slightly weaker than OEM parts in crashes.
  - The product may not match the body and OEM color perfectly.

Please purchase double sided tape, primer and caulking glue at auto accessory shop or hardware store.

Completely degrease and paint primer on all the installation positions to enhance the viscosity of double sided tape.  
Use dryer to warm double sided tape to enhance the viscosity in low temperature.  
Keep the car in a dry condition more than 24 hours after gluing.  
Do not wash the car during this time.

	PARTS	QUANTITIES
TRUNK SPOILER	TRUNK SPOILER	1

 Use caulking glue to fill the gap between the product and the body.

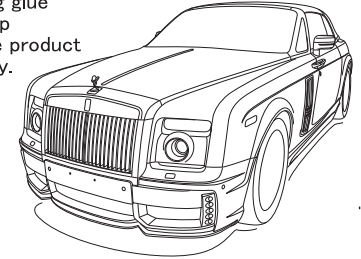

## TRUNK SPOILER

### [BEFORE PAINTING]

- 1) Temporarily put WALD Trunk Spoiler on the trunk.
- 2) Check the fitment, then use masking tape to mark the installation position.

### [AFTER PAINTING]

- 3) Completely degrease the installation position, then use caulking glue to install WALD Trunk Spoiler to the trunk according to the marked position.
- 4) Check all the details of the fitment, leave it till completely fixed.

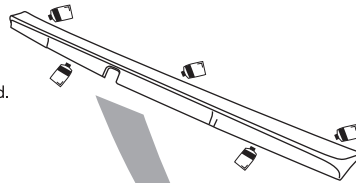

After the installation, use silicon glue to cover the gap between WALD Trunk Spoiler and the body.

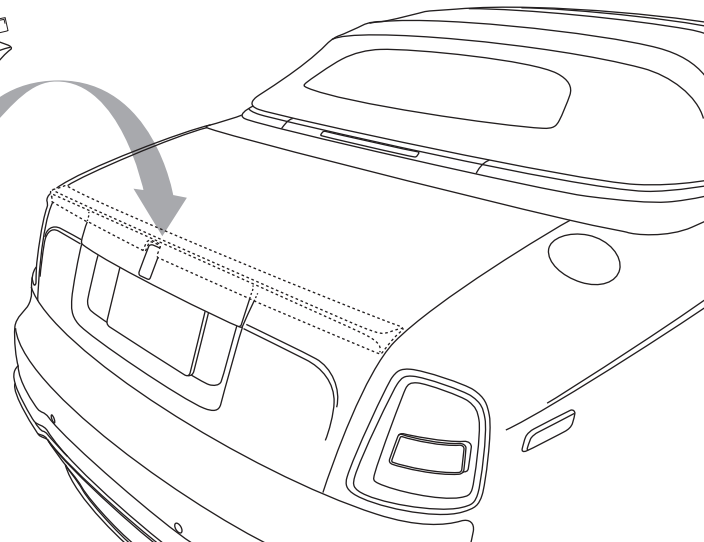

## ATTENTION



- ※ MORE THAN 2 TECHNICIANS ARE NECESSARY IN THIS WORK.
- ※ DURING ALL THE INSTALLATION PROCESS, PLEASE BE CAREFUL NOT TO DAMAGE THE BODY.
- ※ DEGREASE THE INSTALLATION POSITION, AND REMOVE THE BODY PROTECTION COATING BEFORE THE INSTALLATION.
- ※ ADJUST ALL THE DETAILS OF THE FITMENT.

  
WALD INTERNATIONAL

# ROLLS-ROYCE PHANTOM Drophead

WALD SPORTS LINE  
BLACK BISON EDITION

INSTALLATION MANUAL  
**WALD**  
Sportliche Autoausrüstung WALD.International

THANK YOU FOR PURCHASING. THIS IS THE INSTALLATION MANUAL OF LED LAMP KIT OF WALD FRONT BUMPER FOR ROLLS-ROYCE PHANTOM DROPHEAD.  
PLEASE READ THIS MANUAL CAREFULLY BEFORE THE INSTALLATION.

ATTENTION



- ※ NO RETURNS CAN BE ACCEPTED BECAUSE OF IMPROPER INSTALLATION OR PAINTING.
- ※ CHECK THE FITMENT, AND ADJUST ALL THE DETAILS BEFORE PAINTING.
- We assume no responsibility for any damage resulting from improper installation, painting, modification and any cut wound in unsealing.
- Contact the car dealer when you have any question in removing OEM parts.
- During all the installation process, use parking brake and stop the engine completely.
- Use rasps or sandpapers to fit the products to the body if there is an individual difference.
- The product is made of FRP. Handle with care. Do not give the excessive force. Gradually fix the bolts and nuts by checking the fitment and balance of the installation.
- Check the fitment, and adjust all the details of the fitment steady and proper. Please check the fitment and all the details regularly, fix the bolts and nuts as necessary.
- The instruction of painting is just our recommendation, please paint it as you like.
- ※ PLEASE BE AWARE OF:
  - You may lose the warranty and all the services from the car maker, because of replacing OEM parts.
  - Reduced road clearance may cause inconvenience in using parking curbs and garage jack.
  - FRP, ABS and PPE products are slightly weaker than OEM parts in crashes.
  - The product may not match the body and OEM color perfectly.

Please purchase double sided tape, primer and caulking glue at auto accessory shop or hardware store.

Completely degrease and paint primer on all the installation positions to enhance the viscosity of double sided tape.  
Use dryer to warm double sided tape to enhance the viscosity in low temperature.  
Keep the car in a dry condition more than 24 hours after gluing.  
Do not wash the car during this time.

	PARTS	QUANTITIES
LED LAMP KIT	LED LAMPS	1 SET
	LED LAMP BRACKETS	1 SET
	REMOTE CONTROL RELAY HARNESS	1 SET
	BOLTS (M5 x 15)	6



Use caulking glue to fill the gap between the product and the body.

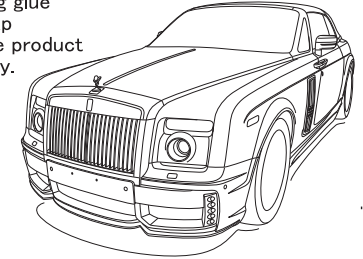

## LED LAMP KIT

### [BEFORE PAINTING]

- 1) Temporarily tighten the attached bolts to install the LED lamp brackets to WALD Front Bumper from the rear.
- ※ Adjust the details of the LED lamp brackets to fit WALD Front Bumper by rasps or sandpapers.
- 2) Check the position and angle of the LED lamps to fit the LED lamp brackets.
- ※ Adjust the details of the LED lamp brackets to fit the LED lamps by rasps or sandpapers.
- 3) Use the attached remote control relay harness to prepare to connect the LED lamps.
- ※ Insulate any spare harness.

### [AFTER PAINTING]

- 4) Check all the details of the fitment, then use caulking glue and masking tape to fix the LED lamps to the LED lamp brackets, leave them till completely fixed.
- 5) Install them to WALD Front Bumper.

### ■ HOW TO INSTALL THE LED LAMPS (STEP 2, 4)

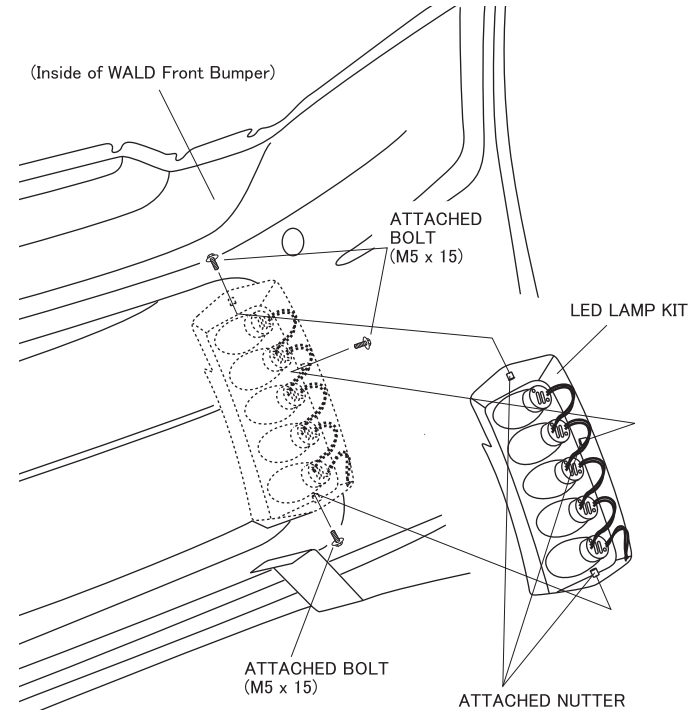
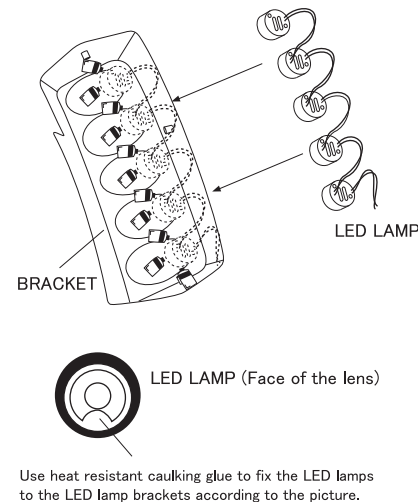

ATTENTION



- ※ DEGREASE ALL THE INSTALLATION POSITIONS, AND REMOVE THE BODY PROTECTION COATING BEFORE THE INSTALLATION.
- ※ MAKE SURE THE LED LAMPS ARE FINE TO WORK BEFORE THE INSTALLATION.

WALD INTERNATIONAL