

PORSCHE CAYENNE 958 (2010y~)

WALD SPORTS LINE
BLACK BISON EDITION

INSTALLATION MANUAL
WALD
Sportliche Autoausrüstung WALD.International

THANK YOU FOR PURCHASING. THIS IS THE INSTALLATION MANUAL OF WALD FRONT BUMPER FOR PORSCHE 958 CAYENNE.
PLEASE READ THIS MANUAL CAREFULLY BEFORE THE INSTALLATION.

ATTENTION



- ※ NO RETURNS CAN BE ACCEPTED BECAUSE OF IMPROPER INSTALLATION OR PAINTING.
- ※ CHECK THE FITMENT, AND ADJUST ALL THE DETAILS BEFORE PAINTING.
- We assume no responsibility for any damage resulting from improper installation, painting, modification and any cut wound in unsealing.
- Contact the car dealer when you have any question in removing OEM parts.
- During all the installation process, use parking brake and stop the engine completely.
- Use rasps or sandpapers to fit the products to the body if there is an individual difference.
- The product is made of FRP. Handle with care. Do not give the excessive force. Gradually fix the bolts and nuts by checking the fitment and balance of the installation.
- Check the fitment, and adjust all the details of the fitment steady and proper. Please check the fitment and all the details regularly, fix the bolts and nuts as necessary.
- The instruction of painting is just our recommendation, please paint it as you like.
- ※ PLEASE BE AWARE OF:
- You may lose the warranty and all the services from the car maker, because of replacing OEM parts.
- Reduced road clearance may cause inconvenience in using parking curbs and garage jack.
- FRP, ABS and PPE products are slightly weaker than OEM parts in crashes.
- The product may not match the body and OEM color perfectly.

Please purchase double sided tape, primer and caulking glue at auto accessory shop or hardware store.

Completely degrease and paint primer on all the installation positions to enhance the viscosity of double sided tape.
Use dryer to warm double sided tape to enhance the viscosity in low temperature.
Keep the car in a dry condition more than 24 hours after gluing.
Do not wash the car during this time.

	PARTS	QUANTITIES
FRONT BUMPER	FRONT BUMPER	1
	LED LAMPS	1 SET
	MESHES	1 SET
	U-SHAPED BRACKETS FOR LICENSE PLATE	1 SET
	BOLTS (M6 x 12)	12
	NUTS (M6)	12
	TAPPING SCREWS	4
U-SHAPED NUTS	2	

Use caulking glue to fill the gap between the product and the body.

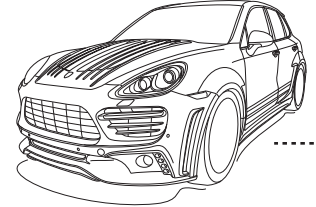

FRONT BUMPER

[BEFORE PAINTING]

- 1) Remove OEM front bumper and rubber fender trims according to the Porsche service manual.
- 2) Make holes along the cutting line on WALD Front Bumper for the car equipping PTS.
- 3) Temporarily relocate OEM parts to WALD Front Bumper.
 - ※ Do not use caulking glue at this point.
- 4) Temporarily install WALD Front Bumper to the body.
 - ※ Adjust the details of WALD Front Bumper to fit the body by rasps or sandpapers.
- 5) Check the balance and fitting, then mark the installation positions for the attached tapping screws at the bottom.
- 6) Make holes along to the marked positions for the attached tapping screws.
- 7) Temporarily install the attached LED lamps to WALD Front Bumper.
 - ※ Make sure the attached LED lamps are fine to work before the installation.
- 8) Paint WALD Front Bumper according to the picture.

[AFTER PAINTING]

- 9) Use pins and caulking glue to install the attached meshes to WALD Front Bumper from the rear.
- 10) Install all the necessary parts to WALD Front Bumper.
- 11) Check all the details of the fitment, then fix them.

ATTENTION

- ※ MORE THAN 2 TECHNICIANS ARE NECESSARY IN THIS WORK. DURING ALL THE INSTALLATION PROCESS, PLEASE BE CAREFUL NOT TO DAMAGE THE BODY.
- ※ ADJUST THE DETAILS OF THE FITMENT IF THERE IS AN INDIVIDUAL DIFFERENCE.

※ WALD SHOWCAR IS PAINTED LIKE THE PICTURE (STEP 8)

■ HOW TO INSTALL THE ATTACHED MESHES (STEP 9)
Fix the attached meshes from the rear with the pins and caulking glue.

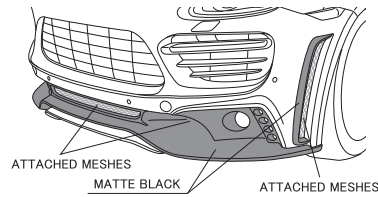

OEM BUMPER DUCT GRILLE

Use caulking glue after fixing OEM bumper duct grille to WALD Front Bumper.

■ HOW TO INSTALL PTS (STEP 2, 10)

Make holes along to the cutting line on WALD Front Bumper, then remove PTS and basement from OEM front bumper and use caulking glue to fix them to WALD Front Bumper from the rear.

■ HOW TO RELOCATE (STEP 10) OEM HEAD LIGHT WASHER

Relocate OEM washer nozzle from OEM front bumper to WALD Front Bumper, then use the attached bolts and nuts to fix tightly.

OEM BOLTS

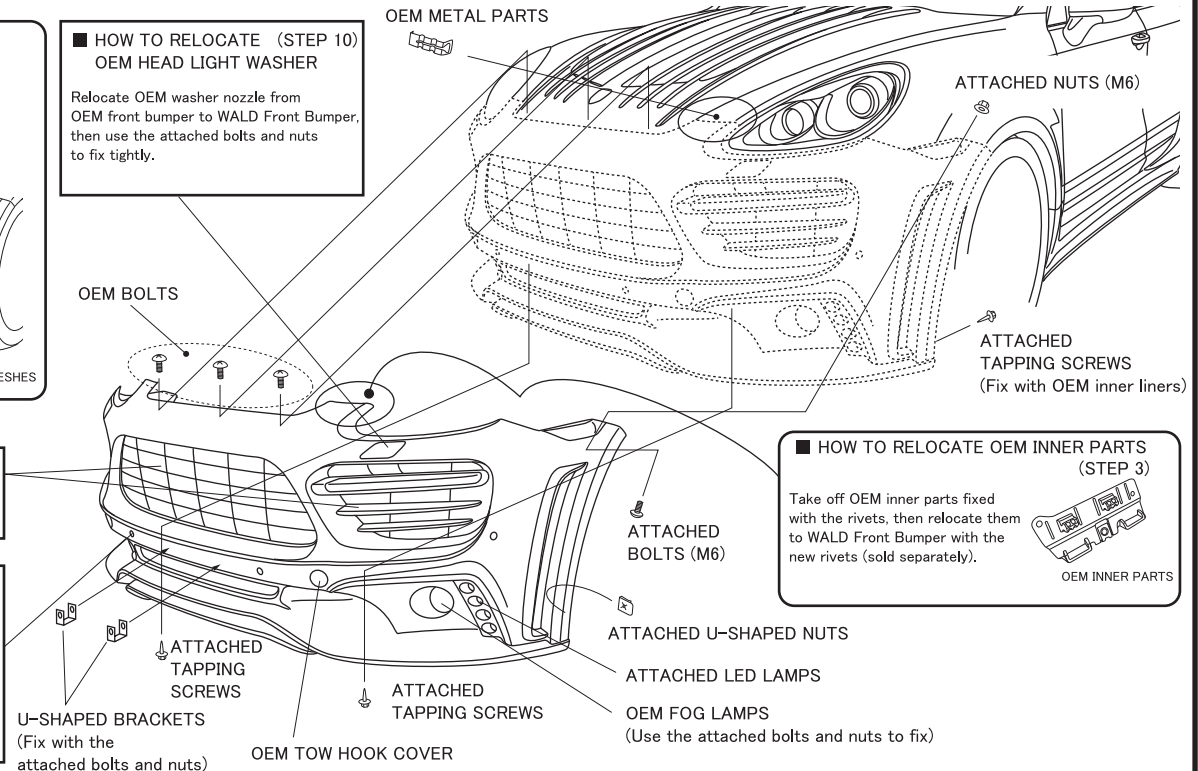

■ HOW TO RELOCATE OEM INNER PARTS (STEP 3)

Take off OEM inner parts fixed with the rivets, then relocate them to WALD Front Bumper with the new rivets (sold separately).

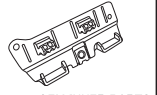

PORSCHE CAYENNE 958 (2010y~)

WALD SPORTS LINE
BLACK BISON EDITION

INSTALLATION MANUAL
WALD
Sportliche Autoausrüstung WALD.International

THANK YOU FOR PURCHASING. THIS IS THE INSTALLATION MANUAL OF LED LAMP OF WALD FRONT BUMPER FOR PORSCHE 958 CAYENNE.
PLEASE READ THIS MANUAL CAREFULLY BEFORE THE INSTALLATION.

ATTENTION



- ※ NO RETURNS CAN BE ACCEPTED BECAUSE OF IMPROPER INSTALLATION OR PAINTING.
- ※ CHECK THE FITMENT, AND ADJUST ALL THE DETAILS BEFORE PAINTING.
- We assume no responsibility for any damage resulting from improper installation, painting, modification and any cut wound in unsealing.
- Contact the car dealer when you have any question in removing OEM parts.
- During all the installation process, use parking brake and stop the engine completely.
- Use rasps or sandpapers to fit the products to the body if there is an individual difference.
- The product is made of FRP. Handle with care. Do not give the excessive force. Gradually fix the bolts and nuts by checking the fitment and balance of the installation.
- Check the fitment, and adjust all the details of the fitment steady and proper. Please check the fitment and all the details regularly, fix the bolts and nuts as necessary.
- The instruction of painting is just our recommendation, please paint it as you like.
- ※ PLEASE BE AWARE OF:
- You may lose the warranty and all the services from the car maker, because of replacing OEM parts.
- Reduced road clearance may cause inconvenience in using parking curbs and garage jack.
- FRP, ABS and PPE products are slightly weaker than OEM parts in crashes.
- The product may not match the body and OEM color perfectly.

Please purchase double sided tape, primer and caulking glue at auto accessory shop or hardware store.

Completely degrease and paint primer on all the installation positions to enhance the viscosity of double sided tape.
Use dryer to warm double sided tape to enhance the viscosity in low temperature.
Keep the car in a dry condition more than 24 hours after gluing.
Do not wash the car during this time.

	PARTS	QUANTITIES
LED LAMP	LED LAMPS	1 SET

Use caulking glue to fill the gap between the product and the body.

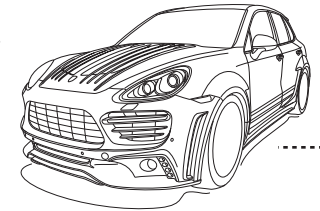

LED LAMP

[BEFORE PAINTING]

- 1) Temporarily fix the attached LED Lamps to WALD Front Bumper from the rear.
- ※ Adjust the details of WALD Front Bumper to fit by rasps or sandpapers.
- 2) Prepare to connect the LED lamps.
- ※ Insulate any spare harness.

[AFTER PAINTING]

- 3) Completely degrease the installation positions, then temporarily fix the attached LED lamps to WALD Front Bumper.
- 4) Use caulking glue to fix the attached LED lamps after checking the proper balance and location.
- 5) Use masking tape to hold the attached LED lamps till completely fixed.
- 6) Connect all the harness, then install WALD Front Bumper to the body.

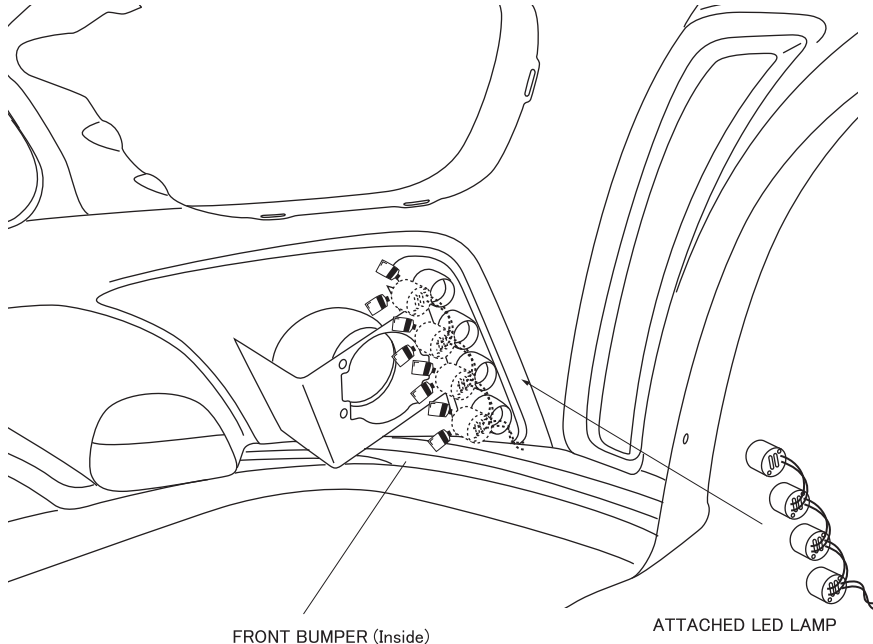

■ HOW TO INSTALL THE LED LAMPS

(STEP 1, 3)



LED LAMP (Face of the lens)

Use heat resistant caulking glue to fix the LED lamps to the LED lamp brackets according to the picture.

ATTENTION

- ※ REMOVE THE BATTERY BEFORE ALL THE WIRING WORKS.
- ※ MAKE SURE THE LED LAMPS ARE FINE TO WORK BEFORE THE INSTALLATION.

= WIRING DIAGRAM =

[AS DAYLIGHT]

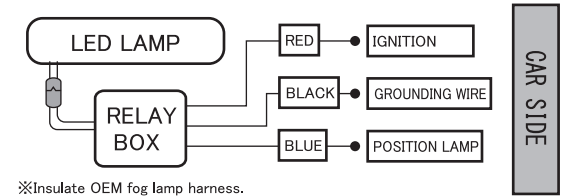

PORSCHE CAYENNE 958 (2010y~)

WALD SPORTS LINE
BLACK BISON EDITION

INSTALLATION MANUAL
WALD
Sportliche Autoausrüstung WALD.International

THANK YOU FOR PURCHASING. THIS IS THE INSTALLATION MANUAL OF WALD SIDE STEPS FOR PORSCHE 958 CAYENNE.
PLEASE READ THIS MANUAL CAREFULLY BEFORE THE INSTALLATION.

ATTENTION



- ※ NO RETURNS CAN BE ACCEPTED BECAUSE OF IMPROPER INSTALLATION OR PAINTING.
- ※ CHECK THE FITMENT, AND ADJUST ALL THE DETAILS BEFORE PAINTING.
- We assume no responsibility for any damage resulting from improper installation, painting, modification and any cut wound in unsealing.
- Contact the car dealer when you have any question in removing OEM parts.
- During all the installation process, use parking brake and stop the engine completely.
- Use rasps or sandpapers to fit the products to the body if there is an individual difference.
- The product is made of FRP. Handle with care. Do not give the excessive force. Gradually fix the bolts and nuts by checking the fitment and balance of the installation.
- Check the fitment, and adjust all the details of the fitment steady and proper. Please check the fitment and all the details regularly, fix the bolts and nuts as necessary.
- The instruction of painting is just our recommendation, please paint it as you like.
- ※ PLEASE BE AWARE OF:
- You may lose the warranty and all the services from the car maker, because of replacing OEM parts.
- Reduced road clearance may cause inconvenience in using parking curbs and garage jack.
- FRP, ABS and PPE products are slightly weaker than OEM parts in crashes.
- The product may not match the body and OEM color perfectly.

Please purchase double sided tape, primer and caulking glue at auto accessory shop or hardware store.

Completely degrease and paint primer on all the installation positions to enhance the viscosity of double sided tape.
Use dryer to warm double sided tape to enhance the viscosity in low temperature.
Keep the car in a dry condition more than 24 hours after gluing.
Do not wash the car during this time.

	PARTS	QUANTITIES
SIDE STEPS	SIDE STEPS	1 SET
	L-SHAPED BRACKETS	2
	Z-SHAPED BRACKETS (Height : 65mm)	4
	Z-SHAPED BRACKETS (Height : 50mm)	2
	BOLTS (M6 x 12)	10
	NUTS (M6)	8
	TAPPING SCREWS	6
RUBBER SPACER	2	

Use caulking glue to fill the gap between the product and the body.

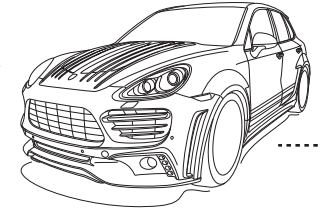

SIDE STEP

[BEFORE PAINTING]

- 1) Remove OEM rubber fenders according to the Porsche service manual.
- 2) Fix the attached L-Shaped brackets to the body according to the picture.
- 3) Temporarily fix the attached Z-Shaped brackets, then install WALD Side Steps to the body.
- ※ Do not fix them forcedly, and adjust the details to fit perfectly.
- 4) Mark the installation positions for the attached Z-Shaped brackets at the center and rear part.
- 5) Take off WALD Side Steps, then make holes according to the marked positions.
- 6) Paint WALD Side Steps according to the picture.

[AFTER PAINTING]

- 7) Fix the attached Z-Shaped brackets to the body.
- 8) Completely degrease the installation positions, then use caulking glue between WALD Side Steps and the body.
- 9) Temporarily fix all the installation fittings.
- 10) Check all the details of the fitment, then fix them.
- 11) Leave them till completely fixed.

※ WALD SHOWCAR IS PAINTED LIKE THE PICTURE (STEP 6)

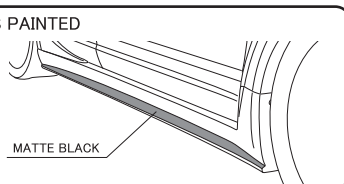

ATTENTION

- ※ MORE THAN 2 TECHNICIANS ARE NECESSARY IN THIS WORK. DURING ALL THE INSTALLATION PROCESS, PLEASE BE CAREFUL NOT TO DAMAGE THE BODY.
- ※ ADJUST THE DETAILS OF THE FITMENT IF THERE IS AN INDIVIDUAL DIFFERENCE.

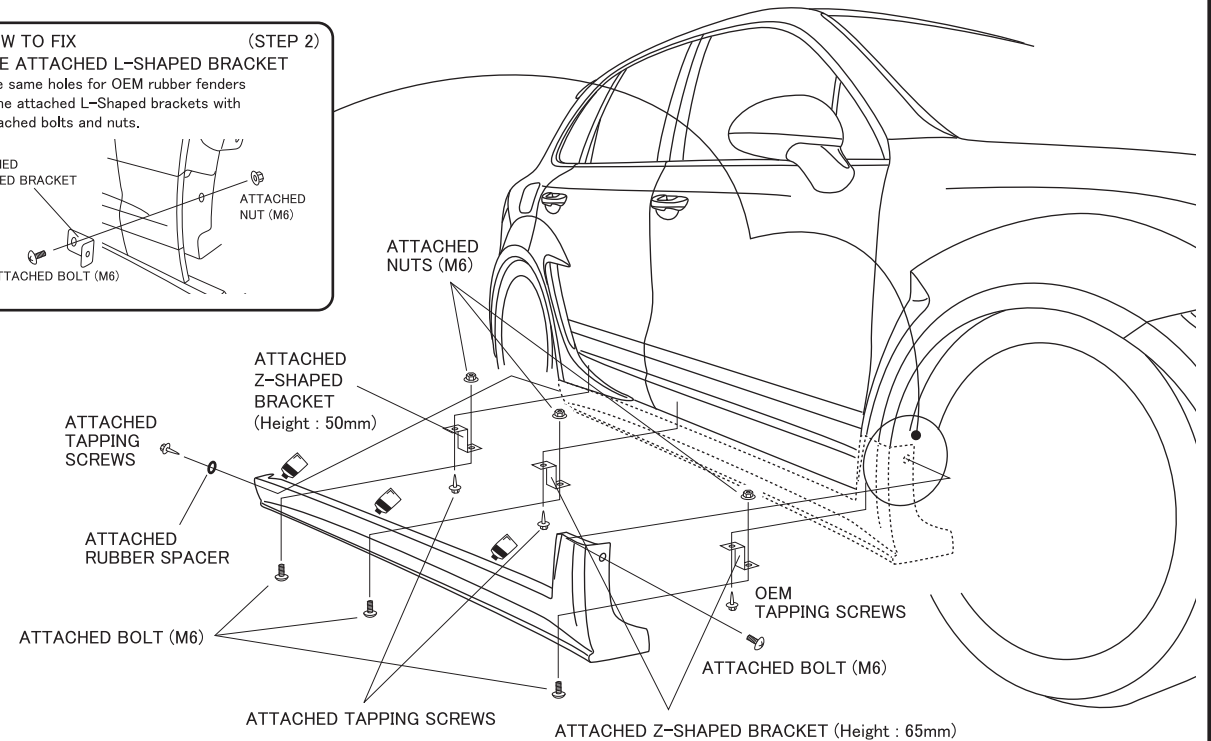
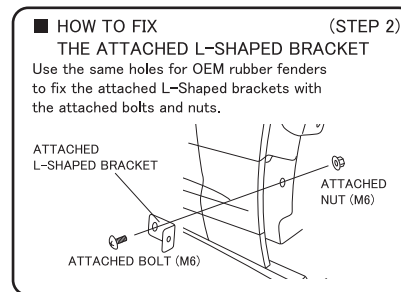

PORSCHE CAYENNE 958 (2010y~)

WALD SPORTS LINE
BLACK BISON EDITION

INSTALLATION MANUAL
WALD
Sportliche Autoausrüstung WALD.International

THANK YOU FOR PURCHASING. THIS IS THE INSTALLATION MANUAL OF WALD REAR BUMPER FOR PORSCHE 958 CAYENNE.
PLEASE READ THIS MANUAL CAREFULLY BEFORE THE INSTALLATION.

ATTENTION



- ※ NO RETURNS CAN BE ACCEPTED BECAUSE OF IMPROPER INSTALLATION OR PAINTING.
- ※ CHECK THE FITMENT, AND ADJUST ALL THE DETAILS BEFORE PAINTING.
- We assume no responsibility for any damage resulting from improper installation, painting, modification and any cut wound in unsealing.
- Contact the car dealer when you have any question in removing OEM parts.
- During all the installation process, use parking brake and stop the engine completely.
- Use rasps or sandpapers to fit the products to the body if there is an individual difference.
- The product is made of FRP. Handle with care. Do not give the excessive force. Gradually fix the bolts and nuts by checking the fitment and balance of the installation.
- Check the fitment, and adjust all the details of the fitment steady and proper. Please check the fitment and all the details regularly, fix the bolts and nuts as necessary.
- The instruction of painting is just our recommendation, please paint it as you like.
- ※ PLEASE BE AWARE OF:
- You may lose the warranty and all the services from the car maker, because of replacing OEM parts.
- Reduced road clearance may cause inconvenience in using parking curbs and garage jack.
- FRP, ABS and PPE products are slightly weaker than OEM parts in crashes.
- The product may not match the body and OEM color perfectly.

Please purchase double sided tape, primer and caulking glue at auto accessory shop or hardware store.

Completely degrease and paint primer on all the installation positions to enhance the viscosity of double sided tape.
Use dryer to warm double sided tape to enhance the viscosity in low temperature.
Keep the car in a dry condition more than 24 hours after gluing.
Do not wash the car during this time.

	PARTS	QUANTITIES
REAR BUMPER	REAR BUMPER	1
	LED REFLECTORS WITH NUTS	1 SET
	MESHES	1 SET
	L-SHAPED BRACKETS	4
	Z-SHAPED BRACKETS	2
	BOLTS (M6 x 12)	12
	NUTS (M6)	8
	REFLECTOR STICKERS	1 SET

Use caulking glue to fill the gap between the product and the body.

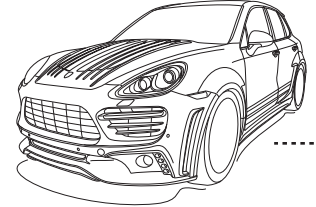

REAR BUMPER

[BEFORE PAINTING]

- 1) Remove OEM rear bumper and rubber fenders according to the Porsche service manual.
 - 2) Fix the attached L-Shaped brackets to the body according to the picture.
 - 3) Make holes along the cutting line on WALD Rear Bumper for the car equipping PTS.
 - 4) Temporarily fix the attached Z-Shaped brackets on WALD Rear Bumper, then install to the body.
- ※ Do not fix them forcibly, and adjust the details to fit perfectly.
- 5) Paint WALD Rear Bumper according to the picture.

[AFTER PAINTING]

- 6) Use pins and caulking glue to install the attached meshes to WALD Rear Bumper from the rear.
 - 7) Install PTS and the attached LED reflectors to WALD Rear Bumper.
- ※ Make sure the attached LED lamp is fine to work before the installation.
- 8) Check all the details of the fitment, then fix all the fittings tightly.

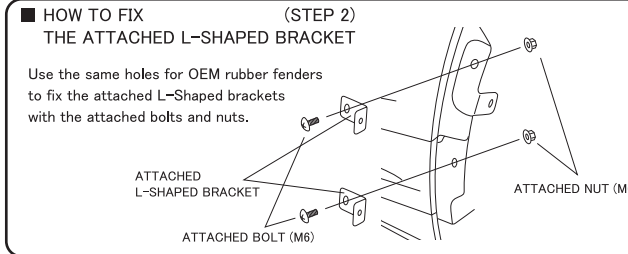

※ WALD SHOWCAR IS PAINTED LIKE THE PICTURE (STEP 5)

■ HOW TO INSTALL THE ATTACHED MESHES (STEP 6)

Fix the attached meshes from the rear with the pins and caulking glue.

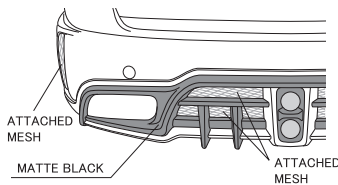

⚠ ATTENTION

- ※ MORE THAN 2 TECHNICIANS ARE NECESSARY IN THIS WORK. DURING ALL THE INSTALLATION PROCESS, PLEASE BE CAREFUL NOT TO DAMAGE THE BODY.
- ※ ADJUST THE DETAILS OF THE FITMENT IF THERE IS AN INDIVIDUAL DIFFERENCE.

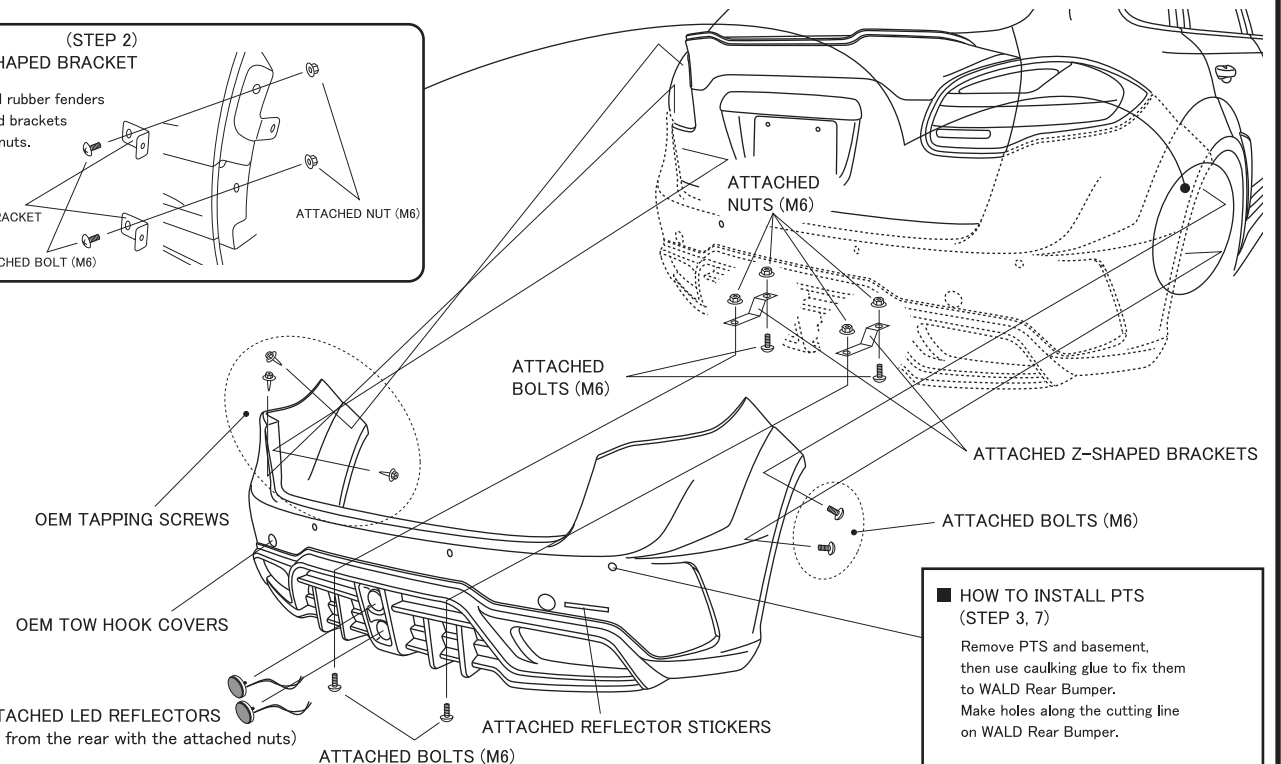

■ HOW TO INSTALL PTS (STEP 3, 7)

Remove PTS and basement, then use caulking glue to fix them to WALD Rear Bumper. Make holes along the cutting line on WALD Rear Bumper.

PORSCHE CAYENNE 958 (2010y~)

WALD SPORTS LINE
BLACK BISON EDITION

INSTALLATION MANUAL
WALD
Sportliche Autoausrüstung WALD.International

THANK YOU FOR PURCHASING. THIS IS THE INSTALLATION MANUAL OF WALD BONNET FOR PORSCHE 958 CAYENNE.
PLEASE READ THIS MANUAL CAREFULLY BEFORE THE INSTALLATION.

ATTENTION



- ※ NO RETURNS CAN BE ACCEPTED BECAUSE OF IMPROPER INSTALLATION OR PAINTING.
- ※ CHECK THE FITMENT, AND ADJUST ALL THE DETAILS BEFORE PAINTING.
- We assume no responsibility for any damage resulting from improper installation, painting, modification and any cut wound in unsealing.
- Contact the car dealer when you have any question in removing OEM parts.
- During all the installation process, use parking brake and stop the engine completely.
- Use rasps or sandpapers to fit the products to the body if there is an individual difference.
- The product is made of FRP. Handle with care. Do not give the excessive force. Gradually fix the bolts and nuts by checking the fitment and balance of the installation.
- Check the fitment, and adjust all the details of the fitment steady and proper. Please check the fitment and all the details regularly, fix the bolts and nuts as necessary.
- The instruction of painting is just our recommendation, please paint it as you like.
- ※ PLEASE BE AWARE OF:
- You may lose the warranty and all the services from the car maker, because of replacing OEM parts.
- Reduced road clearance may cause inconvenience in using parking curbs and garage jack.
- FRP, ABS and PPE products are slightly weaker than OEM parts in crashes.
- The product may not match the body and OEM color perfectly.

Please purchase double sided tape, primer and caulking glue at auto accessory shop or hardware store.

Completely degrease and paint primer on all the installation positions to enhance the viscosity of double sided tape.
Use dryer to warm double sided tape to enhance the viscosity in low temperature.
Keep the car in a dry condition more than 24 hours after gluing.
Do not wash the car during this time.

	PARTS	QUANTITIES
BONNET	BONNET	1
	MESHERS	1 SET

Use caulking glue to fill the gap between the product and the body.

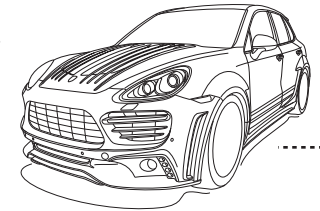

BONNET

[BEFORE PAINTING]

- 1) Remove OEM bonnet according to the Porsche service manual.
- 2) Temporarily install WALD Bonnet to the body after pre-fixing all the necessary parts.
- ※ Adjust the details of WALD Bonnet to fit the body by rasps or sandpapers.
- 3) Paint WALD Bonnet according to the picture.

[AFTER PAINTING]

- 4) Use caulking glue to fix the attached meshes from the rear.
- 5) Fix all the necessary parts to WALD Bonnet, then install to the body.
- 6) Tighten OEM nuts after checking the balance.

■ HOW TO FIX THE ATTACHED MESHES (STEP 4)

Fix the attached meshes from the rear with the pins and caulking glue.

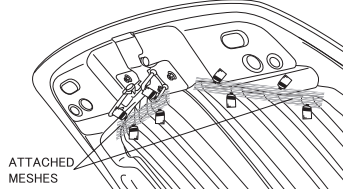

OEM BONNET LOCK (HOOD LATCH)

OEM NUTS

■ HOW TO PUT OEM BONNET BADGE (STEP 5)

Replace OEM bonnet badge to WALD Bonnet.
※ Completely degrease the installation position.

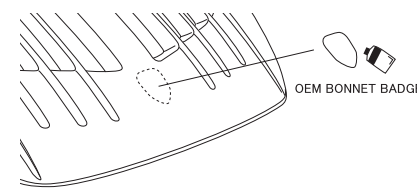

OEM BONNET BADGE

※WALD SHOWCAR IS PAINTED LIKE THE PICTURE (STEP 3)

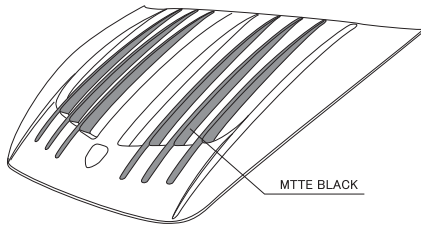

MTE BLACK

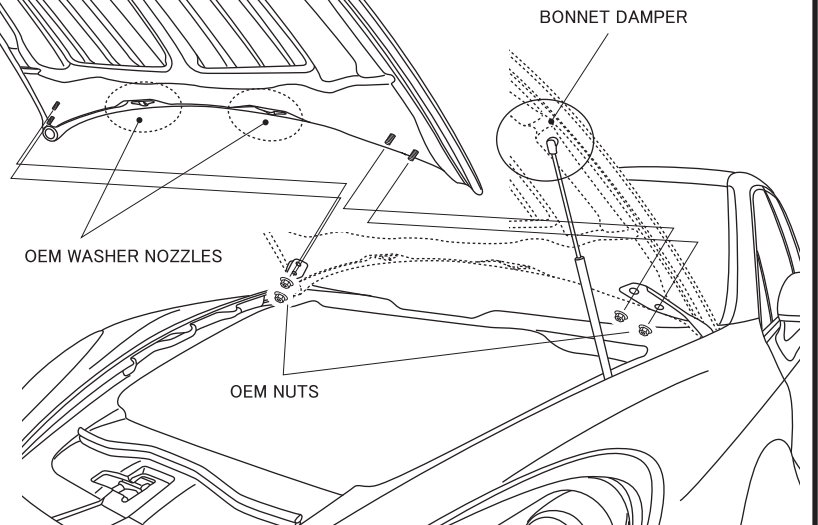

ATTENTION

- ※ MORE THAN 2 TECHNICIANS ARE NECESSARY IN THIS WORK.
- DURING ALL THE INSTALLATION PROCESS, PLEASE BE CAREFUL NOT TO DAMAGE THE BODY.
- ※ ADJUST ALL THE DETAILS OF WALD PRODUCTS TO FIT ON THE BODY.

PORSCHE CAYENNE 958 (2010y~)

WALD SPORTS LINE
BLACK BISON EDITION

INSTALLATION MANUAL
WALD
Sportliche Autoausrüstung WALD.International

THANK YOU FOR PURCHASING. THIS IS THE INSTALLATION MANUAL OF WALD REAR GATE SPOILER AND ROOF SPOILER FOR PORSCHE 958 CAYENNE. PLEASE READ THIS MANUAL CAREFULLY BEFORE THE INSTALLATION.

ATTENTION



- ※ NO RETURNS CAN BE ACCEPTED BECAUSE OF IMPROPER INSTALLATION OR PAINTING.
- ※ CHECK THE FITMENT, AND ADJUST ALL THE DETAILS BEFORE PAINTING.
- We assume no responsibility for any damage resulting from improper installation, painting, modification and any cut wound in unsealing.
- Contact the car dealer when you have any question in removing OEM parts.
- During all the installation process, use parking brake and stop the engine completely.
- Use rasps or sandpapers to fit the products to the body if there is an individual difference.
- The product is made of FRP. Handle with care. Do not give the excessive force. Gradually fix the bolts and nuts by checking the fitment and balance of the installation.
- Check the fitment, and adjust all the details of the fitment steady and proper. Please check the fitment and all the details regularly, fix the bolts and nuts as necessary.
- The instruction of painting is just our recommendation, please paint it as you like.
- ※ PLEASE BE AWARE OF:
- You may lose the warranty and all the services from the car maker, because of replacing OEM parts.
- Reduced road clearance may cause inconvenience in using parking curbs and garage jack.
- FRP, ABS and PPE products are slightly weaker than OEM parts in crashes.
- The product may not match the body and OEM color perfectly.

Please purchase double sided tape, primer and caulking glue at auto accessory shop or hardware store.

Completely degrease and paint primer on all the installation positions to enhance the viscosity of double sided tape.

Use dryer to warm double sided tape to enhance the viscosity in low temperature. Keep the car in a dry condition more than 24 hours after gluing. Do not wash the car during this time.

	PARTS	QUANTITIES
ROOF SPOILER	ROOF SPOILER	1
REAR GATE SPOILER	REAR GATE SPOILER	1
	DOUBLE SIDED TAPE (3 mm Width)	1

Use caulking glue to fill the gap between the product and the body.

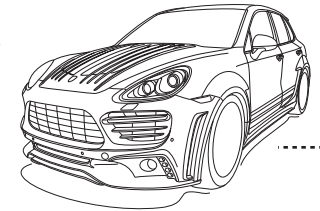

ROOF SPOILER & REAR GATE SPOILER

[BEFORE PAINTING]

- 1) Temporarily install WALD Roof Spoiler and Rear Gate Spoiler to the body.
- 2) Mark the installation positions on the body according to the picture, then remove WALD Rear Gate Spoiler and Roof Spoiler.
- 3) Paint WALD Roof Spoiler and Rear Gate Spoiler according to the picture.

[AFTER PAINTING]

- 4) Use caulking glue to install WALD Rear Gate Spoiler and Roof Spoiler to the body after completely degreasing the installation positions.
- ※ Use the attached double sided tape for WALD Rear Gate Spoiler with caulking glue.
- 5) Use masking tape to hold them after checking the balance and details.
- 6) Leave them till completely fixed.

※WALD SHOWCAR IS PAINTED LIKE THE PICTURE (STEP 3)

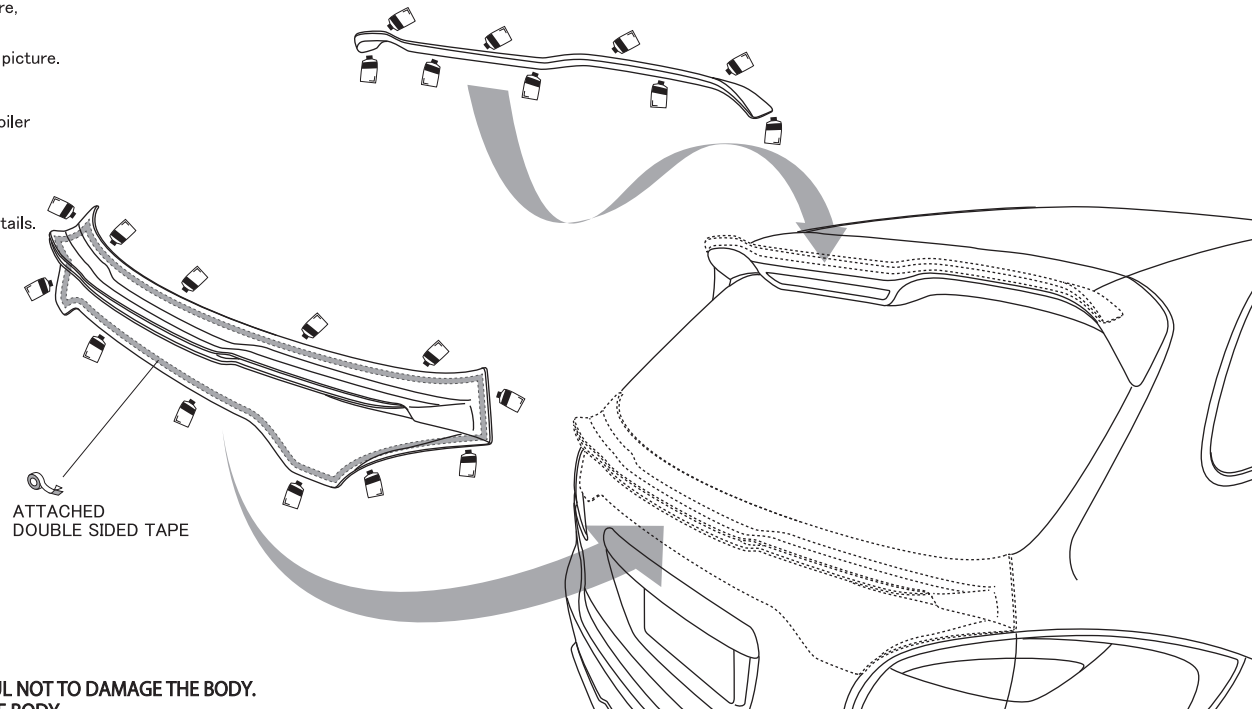
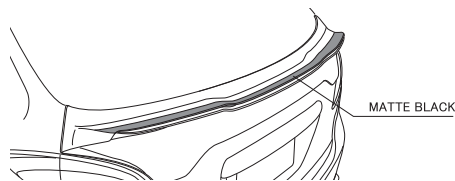

ATTENTION

- ※ MORE THAN 2 TECHNICIANS ARE NECESSARY IN THIS WORK.
- ※ DURING ALL THE INSTALLATION PROCESS, PLEASE BE CAREFUL NOT TO DAMAGE THE BODY.
- ※ ADJUST ALL THE DETAILS OF WALD PRODUCTS TO FIT ON THE BODY.

PORSCHE CAYENNE 958 (2010y~)

WALD SPORTS LINE
BLACK BISON EDITION

INSTALLATION MANUAL
WALD
Sportliche Autoausrüstung WALD.International

THANK YOU FOR PURCHASING. THIS IS THE INSTALLATION MANUAL OF WALD OVER FENDER FOR PORSCHE 958 CAYENNE.
PLEASE READ THIS MANUAL CAREFULLY BEFORE THE INSTALLATION.

ATTENTION



- ※ NO RETURNS CAN BE ACCEPTED BECAUSE OF IMPROPER INSTALLATION OR PAINTING.
- ※ CHECK THE FITMENT, AND ADJUST ALL THE DETAILS BEFORE PAINTING.
- We assume no responsibility for any damage resulting from improper installation, painting, modification and any cut wound in unsealing.
- Contact the car dealer when you have any question in removing OEM parts.
- During all the installation process, use parking brake and stop the engine completely.
- Use rasps or sandpapers to fit the products to the body if there is an individual difference.
- The product is made of FRP. Handle with care. Do not give the excessive force. Gradually fix the bolts and nuts by checking the fitment and balance of the installation.
- Check the fitment, and adjust all the details of the fitment steady and proper. Please check the fitment and all the details regularly, fix the bolts and nuts as necessary.
- The instruction of painting is just our recommendation, please paint it as you like.
- ※ PLEASE BE AWARE OF:
- You may lose the warranty and all the services from the car maker, because of replacing OEM parts.
- Reduced road clearance may cause inconvenience in using parking curbs and garage jack.
- FRP, ABS and PPE products are slightly weaker than OEM parts in crashes.
- The product may not match the body and OEM color perfectly.

Please purchase double sided tape, primer and caulking glue at auto accessory shop or hardware store.

Completely degrease and paint primer on all the installation positions to enhance the viscosity of double sided tape.
Use dryer to warm double sided tape to enhance the viscosity in low temperature.
Keep the car in a dry condition more than 24 hours after gluing.
Do not wash the car during this time.

	PARTS	QUANTITIES
OVER FENDER	OVER FENDER	1 SET
	L-SHAPED BRACKETS	14
	BOLTS (M6 x 12)	28
	NUTS (M6)	14

 Use caulking glue to fill the gap between the product and the body.

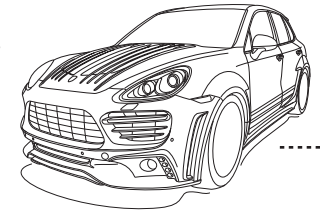

OVER FENDER

【BEFORE PAINTING】

- 1) Remove OEM rubber fender trims according to the Porsche service manual.
- 2) Fix the attached L-Shaped brackets to the body according to the picture.
- 3) Temporarily install WALD Over Fenders to the body.
- ※ Adjust the details of WALD Over Fenders to fit the body by rasps or sandpapers.
- 4) Use masking tape to mark the installation positions for the rear door panel.
- 5) Paint WALD Over Fenders according to the picture.

■ HOW TO INSTALL THE ATTACHED L-SHAPED BRACKETS (STEP 2)

Use the holes of OEM rubber fender trims to fix the attached L-Shaped brackets to the body.

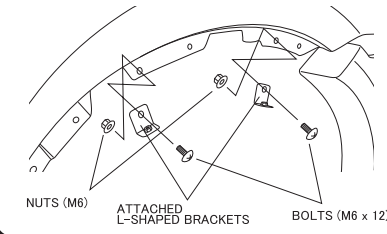

※ WALD SHOWCAR IS PAINTED LIKE THE PICTURE (STEP 5)

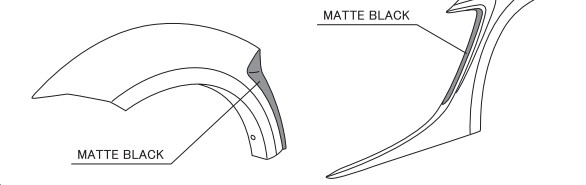

【AFTER PAINTING】

- 6) Completely degrease the installation positions, then use caulking glue to install WALD Over Fenders to the body.
- 7) Check all the balance and details, then fix all the attached bolts tightly.
- 8) Use caulking glue to fix the rear door panels according to the marked positions.
- 9) Leave them till completely fixed.

⚠ ATTENTION

- ※ MORE THAN 2 TECHNICIANS ARE NECESSARY IN THIS WORK.
- ※ DURING ALL THE INSTALLATION PROCESS, PLEASE BE CAREFUL NOT TO DAMAGE THE BODY.
- ※ ADJUST ALL THE DETAILS OF WALD PRODUCTS TO FIT ON THE BODY.

