

# MASERATI Ghibli

(2013y~)

WALD SPORTS LINE  
BLACK BISON EDITION

INSTALLATION MANUAL  
**WALD**  
Sportliche Autoausrüstung WALD International

THANK YOU FOR PURCHASING. THIS IS THE INSTALLATION MANUAL OF WALD FRONT HALF SPOILER FOR MASERATI Ghibli.  
PLEASE READ THIS MANUAL CAREFULLY BEFORE THE INSTALLATION.

## ATTENTION



- ※ NO RETURNS CAN BE ACCEPTED BECAUSE OF IMPROPER INSTALLATION OR PAINTING.
- ※ CHECK THE FITMENT, AND ADJUST ALL THE DETAILS BEFORE PAINTING.
- We assume no responsibility for any damage resulting from improper installation, painting, modification and any cut wound in unsealing.
- Contact the car dealer when you have any question in removing OEM parts.
- During all the installation process, use parking brake and stop the engine completely.
- Use rasps or sandpapers to fit the products to the body if there is an individual difference.
- The product is made of FRP. Handle with care. Do not give the excessive force.
- Gradually fix the bolts and nuts by checking the fitment and balance of the installation.
- Check the fitment, and adjust all the details of the fitment steady and proper.
- Please check the fitment and all the details regularly, fix the bolts and nuts as necessary.
- The instruction of painting is just our recommendation, please paint it as you like.
- ※ PLEASE BE AWARE OF:
  - You may lose the warranty and all the services from the car maker, because of replacing OEM parts.
  - Reduced road clearance may cause inconvenience in using parking curbs and garage jack.
  - FRP, ABS and PPE products are slightly weaker than OEM parts in crashes.
  - The product may not match the body and OEM color perfectly.

Please purchase double sided tape, primer and caulking glue at auto accessory shop or hardware store.

Completely degrease and paint primer on all the installation positions to enhance the viscosity of double sided tape.  
Use dryer to warm double sided tape to enhance the viscosity in low temperature.  
Keep the car in a dry condition more than 24 hours after gluing.  
Do not wash the car during this time.

	PARTS	QUANTITIES
FRONT HALF SPOILER	FRONT HALF SPOILER	1
	LED LAMPS	1 SET
	TAPPING SCREWS (M5 x 16)	2
	LICENSE PLATE BRACKET	1

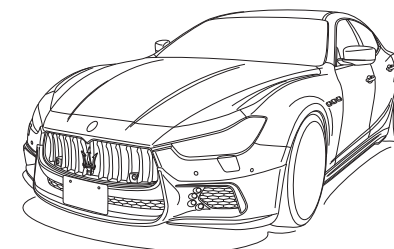

## FRONT HALF SPOILER

### 【BEFORE PAINTING】

- 1) Remove OEM front bumper according to the Maserati service manual.
- 2) Temporarily install WALD Front Half Spoiler on OEM front bumper.
- ※ Adjust the details of WALD Front Half Spoiler to fit OEM front bumper by rasps or sandpapers.
- 3) Need to cut OEM bumper duct meshes to make the space for the attached LED lamps.  
Mark the cut-line on OEM bumper duct meshes according to WALD Front Half Spoiler.
- 4) Cut OEM bumper duct meshes after taking off from OEM front bumper.
- 5) Temporarily install the attached LED lamps on WALD Front Half Spoiler.
- ※ As per enclosure for LED lamp installation.
- 6) Paint WALD Front Half Spoiler according to the picture.

### 【AFTER PAINTING】

- 7) Fix the attached license plate bracket on WALD Front Half Spoiler.
- 8) Completely degrease the installation position.
- 9) Use caulking glue to install WALD Front Half Spoiler to OEM front bumper, then fix all the attached tapping screws tightly.
- 10) Leave it till completely fixed.

## ATTENTION

- ※ MORE THAN 2 TECHNICIANS ARE NECESSARY IN THIS WORK.
- DURING ALL THE INSTALLATION PROCESS, PLEASE BE CAREFUL NOT TO DAMAGE THE BODY.
- ※ ADJUST ALL THE DETAILS OF OUR PRODUCTS TO FIT ON A CAR PERFECTLY.

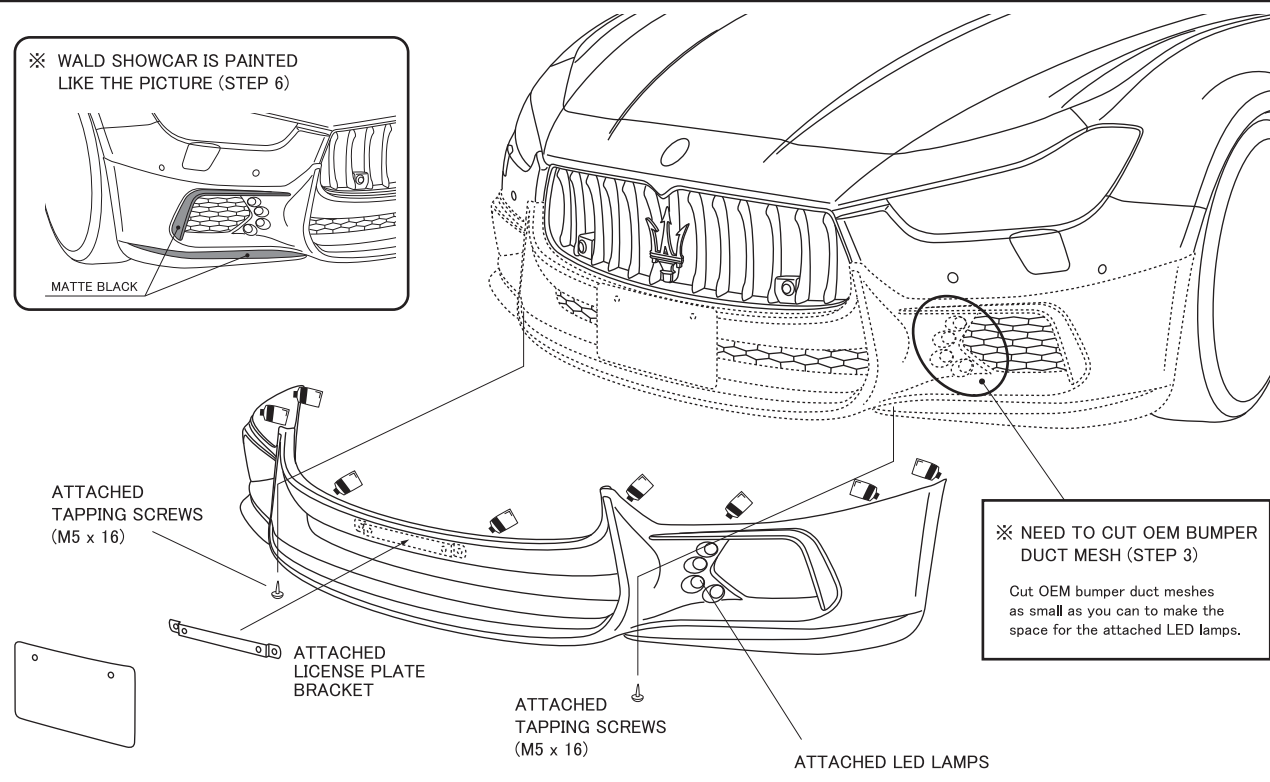
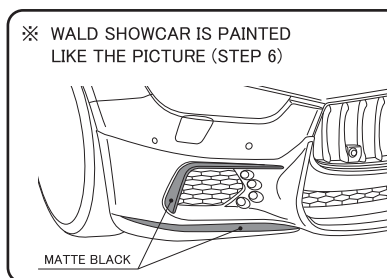

# MASERATI Ghibli

(2013y~)

WALD SPORTS LINE  
BLACK BISON EDITION

INSTALLATION MANUAL  
**WALD**  
Sportliche Autoausrüstung WALD International

THANK YOU FOR PURCHASING. THIS IS THE INSTALLATION MANUAL OF WALD SIDE STEPS FOR MASERATI Ghibli.  
PLEASE READ THIS MANUAL CAREFULLY BEFORE THE INSTALLATION.

## ATTENTION



- ※ NO RETURNS CAN BE ACCEPTED BECAUSE OF IMPROPER INSTALLATION OR PAINTING.
- ※ CHECK THE FITMENT, AND ADJUST ALL THE DETAILS BEFORE PAINTING.
- We assume no responsibility for any damage resulting from improper installation, painting, modification and any cut wound in unsealing.
- Contact the car dealer when you have any question in removing OEM parts.
- During all the installation process, use parking brake and stop the engine completely.
- Use rasps or sandpapers to fit the products to the body if there is an individual difference.
- The product is made of FRP. Handle with care. Do not give the excessive force.
- Gradually fix the bolts and nuts by checking the fitment and balance of the installation.
- Check the fitment, and adjust all the details of the fitment steady and proper.
- Please check the fitment and all the details regularly, fix the bolts and nuts as necessary.
- The instruction of painting is just our recommendation, please paint it as you like.
- ※ PLEASE BE AWARE OF:
  - You may lose the warranty and all the services from the car maker, because of replacing OEM parts.
  - Reduced road clearance may cause inconvenience in using parking curbs and garage jack.
  - FRP, ABS and PPE products are slightly weaker than OEM parts in crashes.
  - The product may not match the body and OEM color perfectly.

Please purchase double sided tape, primer and caulking glue at auto accessory shop or hardware store.

Completely degrease and paint primer on all the installation positions to enhance the viscosity of double sided tape.  
Use dryer to warm double sided tape to enhance the viscosity in low temperature.  
Keep the car in a dry condition more than 24 hours after gluing.  
Do not wash the car during this time.

	PARTS	QUANTITIES
SIDE STEP	SIDE STEPS	1 SET
	TAPPING SCREWS (M5 x 16)	10

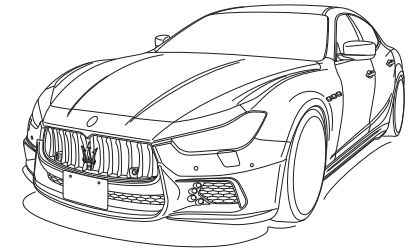

## SIDE STEP

### 【BEFORE PAINTING】

- 1) Temporarily install WALD Side Steps to the body.
- ※ Adjust the details of WALD Sides Steps to fit the body by rasps or sandpapers.
- 2) According to the holes on WALD Side Steps, mark the hole locations on the body for the attached tapping screws.
- 3) Take off WALD Side Steps from the body, then make holes according to the marked positions.
- 4) Paint WALD Side Steps.

### 【AFTER PAINTING】

- 5) Completely degrease the installation position.
- 6) Use caulking glue to install WALD Side Steps to the body, then fix the attached tapping screws tightly.
- 7) Leave them till completely fixed.

ATTACHED  
TAPPING SCREWS (M5 x 16)

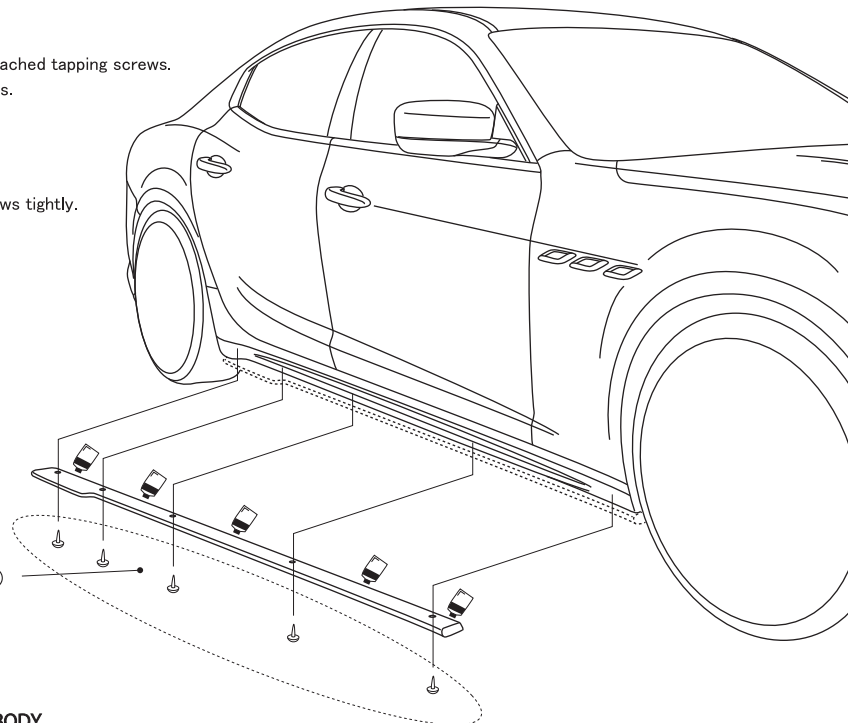

## ATTENTION

- ※ MORE THAN 2 TECHNICIANS ARE NECESSARY IN THIS WORK.
- ※ DURING ALL THE INSTALLATION PROCESS, PLEASE BE CAREFUL NOT TO DAMAGE THE BODY.
- ※ ADJUST ALL THE DETAILS OF OUR PRODUCTS TO FIT ON A CAR PERFECTLY.



# MASERATI GHIBLI

(2013y~)

WALD SPORTS LINE  
BLACK BISON EDITION

INSTALLATION MANUAL  
**WALD**  
Sportliche Autoausrüstung WALD International

THANK YOU FOR PURCHASING. THIS IS THE INSTALLATION MANUAL OF WALD REAR SKIRT FOR MASERATI GHIBLI.  
PLEASE READ THIS MANUAL CAREFULLY BEFORE THE INSTALLATION.

## ATTENTION



- ※ NO RETURNS CAN BE ACCEPTED BECAUSE OF IMPROPER INSTALLATION OR PAINTING.
- ※ CHECK THE FITMENT, AND ADJUST ALL THE DETAILS BEFORE PAINTING.
- We assume no responsibility for any damage resulting from improper installation, painting, modification and any cut wound in unsealing.
- Contact the car dealer when you have any question in removing OEM parts.
- During all the installation process, use parking brake and stop the engine completely.
- Use rasps or sandpapers to fit the products to the body if there is an individual difference.
- The product is made of FRP. Handle with care. Do not give the excessive force.
- Gradually fix the bolts and nuts by checking the fitment and balance of the installation.
- Check the fitment, and adjust all the details of the fitment steady and proper.
- Please check the fitment and all the details regularly, fix the bolts and nuts as necessary.
- The instruction of painting is just our recommendation, please paint it as you like.
- ※ PLEASE BE AWARE OF:
  - You may lose the warranty and all the services from the car maker, because of replacing OEM parts.
  - Reduced road clearance may cause inconvenience in using parking curbs and garage jack.
  - FRP, ABS and PPE products are slightly weaker than OEM parts in crashes.
  - The product may not match the body and OEM color perfectly.

Please purchase double sided tape, primer and caulking glue at auto accessory shop or hardware store.

Completely degrease and paint primer on all the installation positions to enhance the viscosity of double sided tape.  
Use dryer to warm double sided tape to enhance the viscosity in low temperature.  
Keep the car in a dry condition more than 24 hours after gluing.  
Do not wash the car during this time.

	PARTS	QUANTITIES
REAR SKIRT	REAR SKIRT	1
	MESHES	1 SET
	LED LAMP WITH NUTS	1
	TAPPING SCREWS (M5 x 16)	2

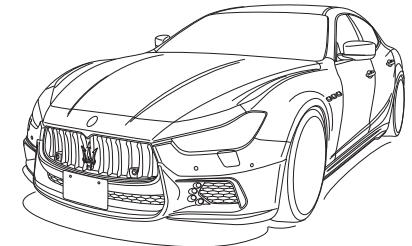

## REAR SKIRT

### 【BEFORE PAINTING】

- 1) Remove OEM rear diffuser according to the Maserati service manual.
- 2) Temporarily install WALD Rear Skirt to the body.
- ※ Adjust the details of WALD Rear Skirt to fit the body by rasps or sandpapers.
- 3) Check the balance of the installation position of WALD Rear Skirt on OEM rear bumper.
- 4) Need to cut OEM rear bumper to make the space for the attached LED lamp. Mark the cut-line on OEM rear bumper according to WALD Rear Skirt.
- 5) Cut OEM rear bumper according to the marked cut-line, then prepare to connect the attached LED lamp.
- 6) Paint WALD Rear Skirt according to the picture.

- ※ WALD SHOWCAR IS PAINTED LIKE THE PICTURE (STEP 6)
- HOW TO INSTALL THE ATTACHED MESHES (STEP 7)

Use pins and caulking glue to install the attached meshes to WALD Rear Skirt from the rear.  
※Paint the inside of the ducts and pins in black.

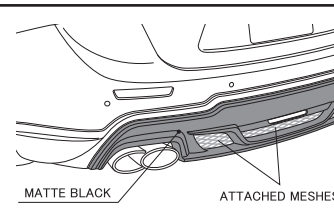

- HOW TO INSTALL THE LED LAMP (STEP 8)

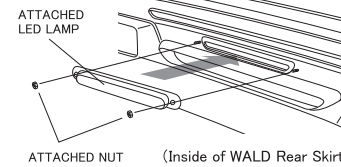

### 【AFTER PAINTING】

- 7) Install the attached meshes with caulking glue to WALD Rear Skirt from the rear.
- 8) Install the attached LED lamp on WALD Rear Skirt.
- ※ Make sure the LED lamp is fine to work before the installation.
- 9) Completely degrease the installation position of WALD Rear Skirt and OEM rear bumper.
- 10) Use caulking glue to install WALD Rear Skirt to OEM rear bumper, then fix all the attached tapping screws tightly.
- 11) Check all the details of the fitment, leave it till completely fixed.

## ATTENTION

- ※ MORE THAN 2 TECHNICIANS ARE NECESSARY IN THIS WORK. DURING ALL THE INSTALLATION PROCESS, PLEASE BE CAREFUL NOT TO DAMAGE THE BODY.
- ※ MAKE SURE THE ATTACHED LED LAMPS IS FINE TO WORK BEFORE THE INSTALLATION
- ※ ADJUST ALL THE DETAILS OF OUR PRODUCTS TO FIT ON A CAR PERFECTLY.

ATTACHED TAPPING SCREWS (M5 x 16)

ATTACHED LED LAMP

ATTACHED TAPPING SCREWS (M5 x 16)

NEED TO CUT OEM REAR BUMPER (STEP 4)

# MASERATI Ghibli (2013y~)

WALD SPORTS LINE  
BLACK BISON EDITION

INSTALLATION MANUAL  
**WALD**  
Sportliche Autoausrüstung WALD International

THANK YOU FOR PURCHASING. THIS IS THE INSTALLATION MANUAL OF WALD TRUNK SPOILER FOR MASERATI Ghibli.  
PLEASE READ THIS MANUAL CAREFULLY BEFORE THE INSTALLATION.

## ATTENTION



- ※ NO RETURNS CAN BE ACCEPTED BECAUSE OF IMPROPER INSTALLATION OR PAINTING.
- ※ CHECK THE FITMENT, AND ADJUST ALL THE DETAILS BEFORE PAINTING.
- We assume no responsibility for any damage resulting from improper installation, painting, modification and any cut wound in unsealing.
- Contact the car dealer when you have any question in removing OEM parts.
- During all the installation process, use parking brake and stop the engine completely.
- Use rasps or sandpapers to fit the products to the body if there is an individual difference.
- The product is made of FRP. Handle with care. Do not give the excessive force.
- Gradually fix the bolts and nuts by checking the fitment and balance of the installation.
- Check the fitment, and adjust all the details of the fitment steady and proper.
- Please check the fitment and all the details regularly, fix the bolts and nuts as necessary.
- The instruction of painting is just our recommendation, please paint it as you like.
- ※ PLEASE BE AWARE OF:
  - You may lose the warranty and all the services from the car maker, because of replacing OEM parts.
  - Reduced road clearance may cause inconvenience in using parking curbs and garage jack.
  - FRP, ABS and PPE products are slightly weaker than OEM parts in crashes.
  - The product may not match the body and OEM color perfectly.

Please purchase double sided tape, primer and caulking glue at auto accessory shop or hardware store.

Completely degrease and paint primer on all the installation positions to enhance the viscosity of double sided tape.  
Use dryer to warm double sided tape to enhance the viscosity in low temperature.  
Keep the car in a dry condition more than 24 hours after gluing.  
Do not wash the car during this time.

	PARTS	QUANTITIES
TRUNK SPOILER	TRUNK SPOILER	1

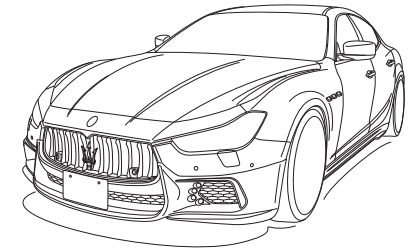

## TRUNK SPOILER

### 【BEFORE PAINTING】

- 1) Temporarily install WALD Trunk Spoiler to the body.
- 2) Check the fitment, then use masking tape to mark the installation position.

### 【AFTER PAINTING】

- 3) Completely degrease the installation position.
- 4) Use caulking glue to install WALD Trunk Spoiler to the body according to the marked position.
- 5) Check all the details of the fitment, and leave it till completely fixed.

※CARBON PRODUCT  
Clear-Coat the surface of the product.

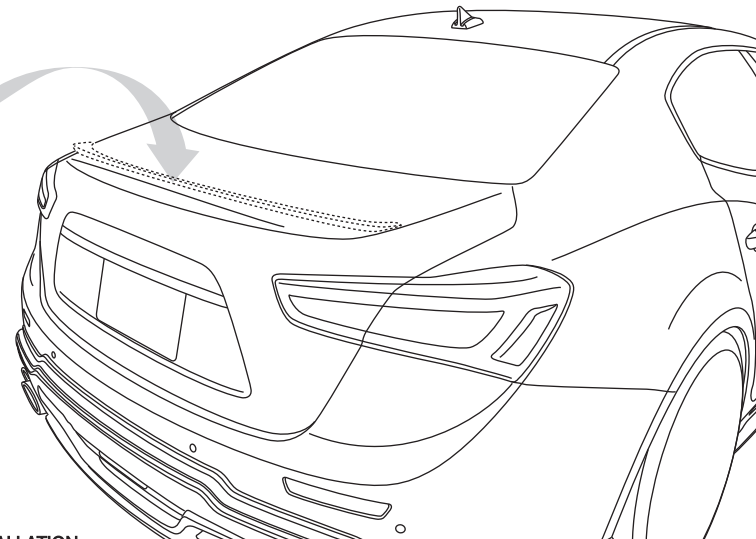
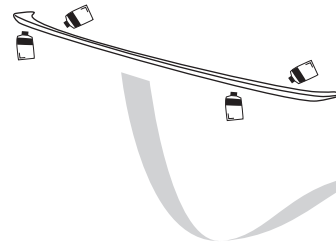
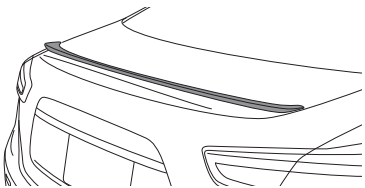

## ATTENTION

- ※ MORE THAN 2 TECHNICIANS ARE NECESSARY IN THIS WORK.
- ※ DURING ALL THE INSTALLATION PROCESS, PLEASE BE CAREFUL NOT TO DAMAGE THE BODY.
- ※ DEGREASE ALL THE INSTALLATION POSITION, AND REMOVE THE BODY PROTECTION COATING BEFORE THE INSTALLATION.

WALD INTERNATIONAL



# MASERATI Ghibli

(2013y~)

WALD SPORTS LINE  
BLACK BISON EDITION

INSTALLATION MANUAL  
**WALD**  
Sportliche Autoausrüstung WALD International

THANK YOU FOR PURCHASING. THIS IS THE INSTALLATION MANUAL OF LED LAMPS ON WALD FRONT BUMPER FOR MASERATI Ghibli.  
PLEASE READ THIS MANUAL CAREFULLY BEFORE THE INSTALLATION.

ATTENTION



- ※ NO RETURNS CAN BE ACCEPTED BECAUSE OF IMPROPER INSTALLATION OR PAINTING.
- ※ CHECK THE FITMENT, AND ADJUST ALL THE DETAILS BEFORE PAINTING.
- We assume no responsibility for any damage resulting from improper installation, painting, modification and any cut wound in unsealing.
- Contact the car dealer when you have any question in removing OEM parts.
- During all the installation process, use parking brake and stop the engine completely.
- Use rasps or sandpapers to fit the products to the body if there is an individual difference.
- The product is made of FRP. Handle with care. Do not give the excessive force.
- Gradually fix the bolts and nuts by checking the fitment and balance of the installation.
- Check the fitment, and adjust all the details of the fitment steady and proper.
- Please check the fitment and all the details regularly, fix the bolts and nuts as necessary.
- The instruction of painting is just our recommendation, please paint it as you like.
- ※ PLEASE BE AWARE OF:
  - You may lose the warranty and all the services from the car maker, because of replacing OEM parts.
  - Reduced road clearance may cause inconvenience in using parking curbs and garage jack.
  - FRP, ABS and PPE products are slightly weaker than OEM parts in crashes.
  - The product may not match the body and OEM color perfectly.

Please purchase double sided tape, primer and caulking glue at auto accessory shop or hardware store.

Completely degrease and paint primer on all the installation positions to enhance the viscosity of double sided tape.  
Use dryer to warm double sided tape to enhance the viscosity in low temperature.  
Keep the car in a dry condition more than 24 hours after gluing.  
Do not wash the car during this time.

	PARTS	QUANTITIES
LED LAMP	LED LAMP	1 SET

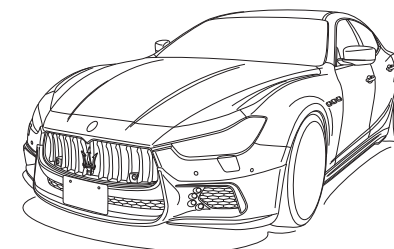

## LED LAMP

### 【BEFORE PAINTING】

- 1) Temporarily fix the attached LED lamps according to the holes on WALD Front Half Spoiler.
- ※ Adjust the details of WALD Front Half Spoiler to fit the attached LED lamps by rasps or sandpapers.
- 2) Prepare to connect the attached LED lamps.
- ※ Insulate any spare harness.

### 【AFTER PAINTING】

- 3) Completely degrease the installation positions, then put the attached LED lamps according to the holes on WALD Front Half Spoiler.
- 4) Use caulking glue to fix the attached LED lamps after checking the angle and location.
- 5) Leave them till completely fixed.
- 6) Install WALD Front Half Spoiler to OEM front bumper after connecting the harness.

#### ■ HOW TO INSTALL THE ATTACHED LED LAMPS (STEP 1, 3)



Use heat resistant caulking glue to fix the attached LED lamps on WALD Front Half Spoiler according to the picture.

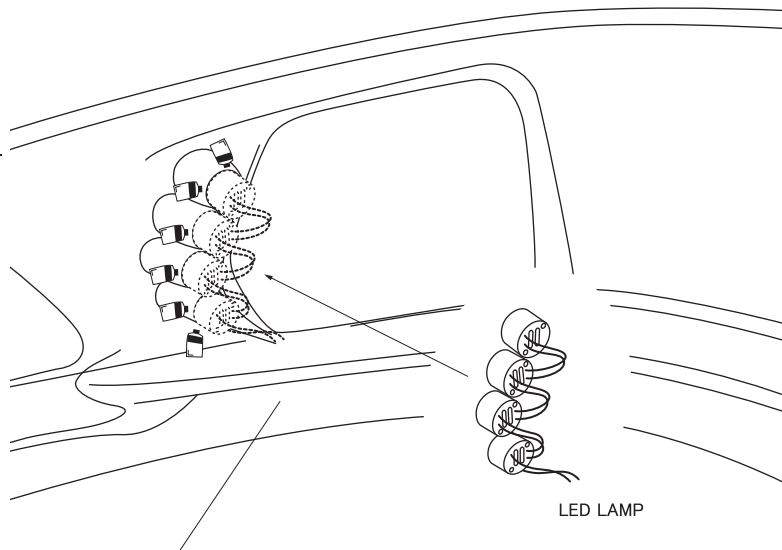

(Inside of WALD Front Half Spoiler)

### = WIRING DIAGRAM =

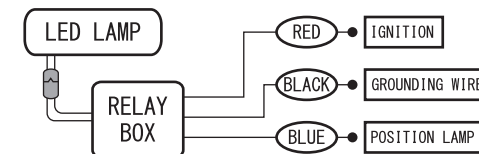

※ RED: Connect the harness with the cigarette lighter receptacle.

ATTENTION

- ※ REMOVE THE BATTERY BEFORE ALL THE WIRING WORKS.
- ※ MAKE SURE OEM FOG LAMPS ARE FINE TO WORK BEFORE THE INSTALLATION.

