

Mercedes Benz E-class W212 (2013y~)

WALD SPORTS LINE
BLACK BISON EDITION

INSTALLATION MANUAL
WALD
Sportliche Autoausrüstung WALD.International

THANK YOU FOR PURCHASING. THIS IS THE INSTALLATION MANUAL OF WALD FRONT BUMPER FOR MERCEDES-BENZ W212 E-CLASS.
PLEASE READ THIS MANUAL CAREFULLY BEFORE THE INSTALLATION.

ATTENTION



- ※ NO RETURNS CAN BE ACCEPTED BECAUSE OF IMPROPER INSTALLATION OR PAINTING.
- ※ CHECK THE FITMENT, AND ADJUST ALL THE DETAILS BEFORE PAINTING.
- We assume no responsibility for any damage resulting from improper installation, painting, modification and any cut wound in unsealing.
- Contact the car dealer when you have any question in removing OEM parts.
- During all the installation process, use parking brake and stop the engine completely.
- Use rasps or sandpapers to fit the products to the body if there is an individual difference.
- The product is made of FRP. Handle with care. Do not give the excessive force.
- Gradually fix the bolts and nuts by checking the fitment and balance of the installation.
- Check the fitment, and adjust all the details of the fitment steady and proper.
- Please check the fitment and all the details regularly, fix the bolts and nuts as necessary.
- The instruction of painting is just our recommendation, please paint it as you like.
- ※ PLEASE BE AWARE OF:
- You may lose the warranty and all the services from the car maker, because of replacing OEM parts.
- Reduced road clearance may cause inconvenience in using parking curbs and garage jack.
- FRP, ABS and PPE products are slightly weaker than OEM parts in crashes.
- The product may not match the body and OEM color perfectly.

Please purchase double sided tape, primer and caulking glue at auto accessory shop or hardware store.

Completely degrease and paint primer on all the installation positions to enhance the viscosity of double sided tape.
Use dryer to warm double sided tape to enhance the viscosity in low temperature.
Keep the car in a dry condition more than 24 hours after gluing.
Do not wash the car during this time.

	PARTS	QUANTITIES
FRONT BUMPER	FRONT BUMPER	1
	LED LAMP KIT	1 SET
	LICENSE PLATE BASEMENT	1
	MESHES	1 SET
	TOW HOOK COVER	1
	BRACKET (LEFT/RIGHT)	1 SET
	BOLTS (M6 x 12) & NUTS	4 SETS
	BOLTS (M4 x 16) & NUTS	8 SETS

Use caulking glue to fill the gap between the product and the body.

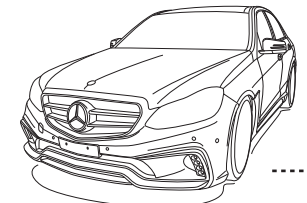

FRONT BUMPER

【BEFORE PAINTING】

- 1) Remove OEM front bumper according to the Mercedes-Benz service manual.
- 2) Make holes along to the cutting line on WALD Front Bumper for the car equipping PTS.
- 3) Temporarily relocate OEM bumper support to WALD Front Bumper.
then install it to the body with the attached brackets.
- ※ Adjust the details of WALD Front Bumper to fit the body by rasps or sandpapers. (As per enclosures)
- 4) Take off WALD Front Bumper from the body and temporarily fix the attached license plate basement and LED lamps to see the fitting.
- ※ As per enclosure for LED lamp installation.
- 5) Paint WALD Front Bumper according to the picture.

【AFTER PAINTING】

- 6) Use pins and caulking glue to install the attached meshes to WALD Front Bumper from the rear.
- 7) Install PTS and the attached LED lamp kit, then install WALD Front Bumper to the body.
- ※ Make sure the attached LED lamp kit is fine to work before the installation.
- 8) Check all the details of the fitment, then tighten all the bolts, nuts and tapping screws.

※ WALD SHOWCAR IS PAINTED LIKE THE PICTURE (STEP 5)

■ HOW TO INSTALL THE ATTACHED MESHES (STEP 6)

Use pins and caulking glue to install the attached meshes to WALD Front Bumper from the rear.

※ Paint the inside of the ducts and pins in black.

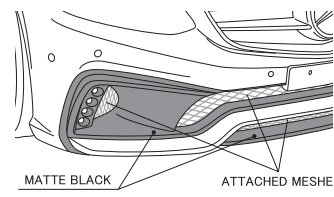

ATTACHED BOLTS (M4 x 16)
(To hold OEM inner parts)

OEM BOLTS

ATTACHED NUTS(M4)

OEM FRONT GRILLE
(Use the attached bolts and nuts
(M4 x 16) to fix)

ATTACHED TOW HOOK COVER
(Use double sticky tape to fix)

ATTACHED LICENSE PLATE BASEMENT
(Fix with the attached bolts (M6 x 12))

ATTACHED BOLTS
(M6 x 12)

ATTACHED LED LAMPS

OEM TAPPING SCREWS

OEM TAPPING SCREWS

ATTACHED BRACKET (LEFT)

※ Brackets for Left and Right are in different shape although the same installation procedure)

ATTACHED NUTS (M6)

ATTACHED BRACKET (RIGHT)

OEM CLIPS

※ Fix with the inner liner to WALD Front Bumper

ATTENTION

- ※ MORE THAN 2 TECHNICIANS ARE NECESSARY IN THIS WORK.
- DURING ALL THE INSTALLATION PROCESS, PLEASE BE CAREFUL NOT TO DAMAGE THE BODY.
- ※ ADJUST ALL THE DETAILS OF OUR PRODUCTS TO FIT ON A CAR PERFECTLY.

■ HOW TO INSTALL PTS (STEP 2, 7)

Make holes along the cutting line on WALD Front Bumper.
Remove OEM PTS and the basement, then use caulking glue to fix them to WALD Front Bumper from the rear.

THANK YOU FOR PURCHASING. THIS IS THE INSTALLATION MANUAL OF HOW TO ADJUST OEM INNER PARTS TO FIT WITH WALD FRONT BUMPER FOR W212 E-CLASS.

OEM INNER PARTS FOR FRONT BUMPER

Cut and Shave OEM inner parts according to the red lines on the pictures to fit with WALD Front Bumper.
※The shape and size of OEM inner parts depend on Grade and Model. Therefore the pictures here are just for your reference.
Main idea is to adjust the shape of OEM inner parts to fit on WALD Front Bumper.

BEFORE

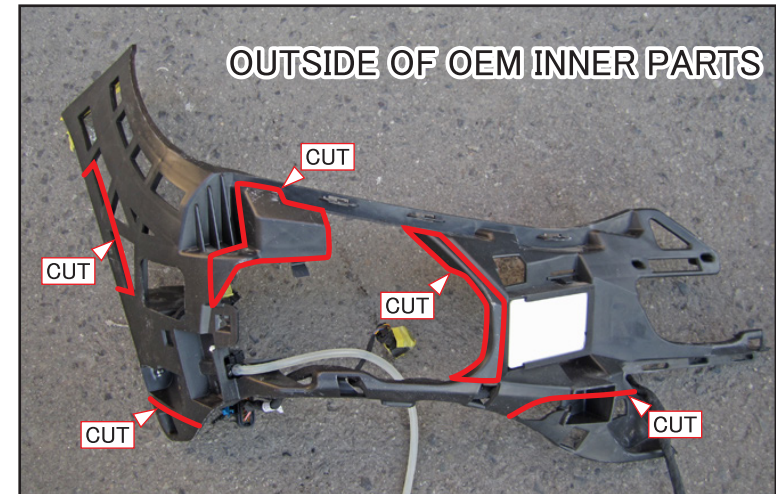
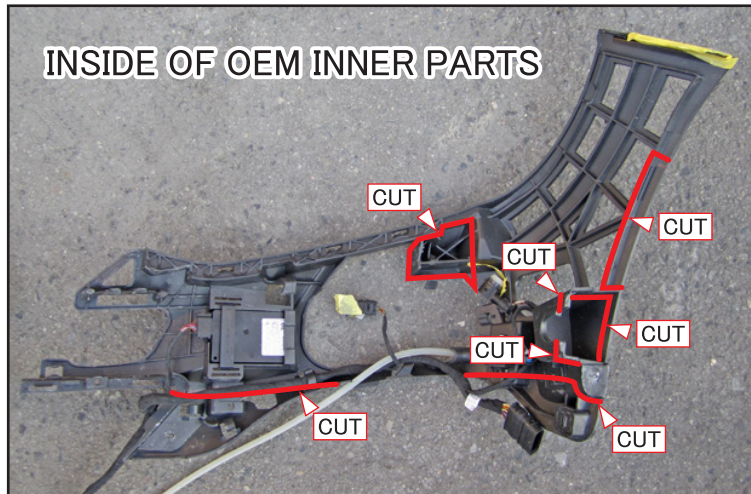

AFTER

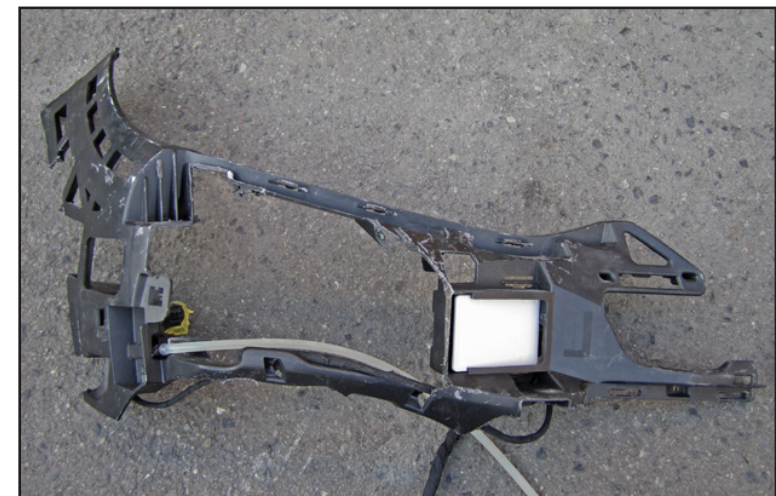

THANK YOU FOR PURCHASING. THIS IS THE INSTALLATION MANUAL OF HOW TO ADJUST OEM INNER PARTS TO FIT WITH WALD FRONT BUMPER FOR W212 E-CLASS.

MODIFICATION FOR INSIDE OF WALD FRONT BUMPER

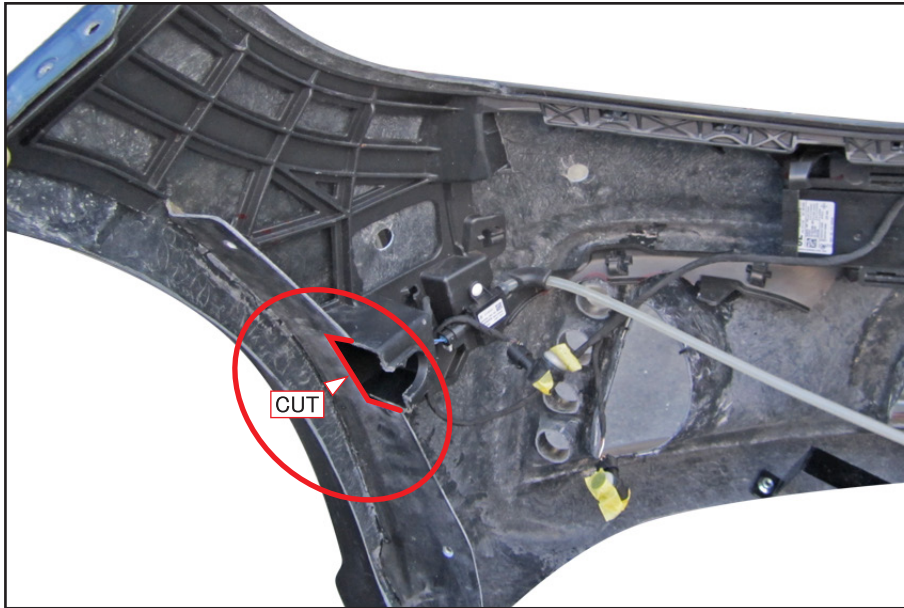

Temporarily fix OEM inner parts to WALD Front Bumper,
then cut the inner-liner plate according to the red line in a red circle.

OEM ENERGY ABSORBER FOR FRONT BUMPER

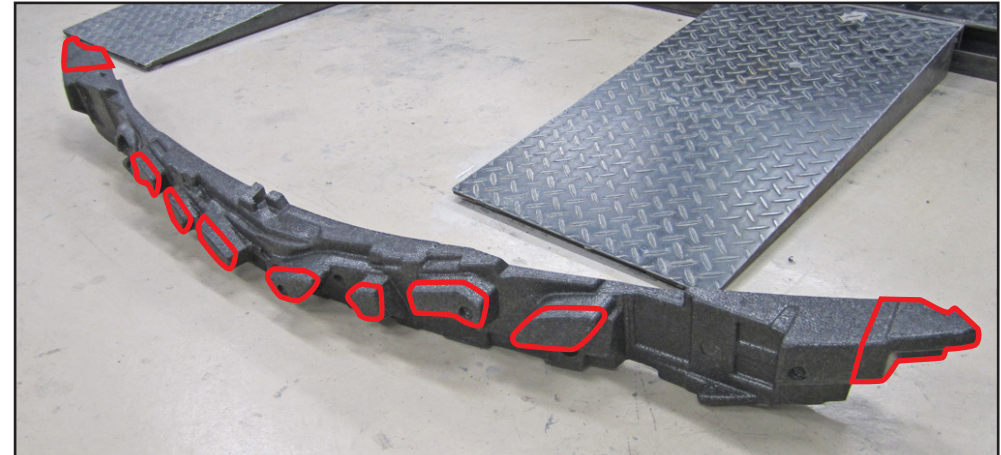

According to the red circles, cut the convexes on the surface of OEM energy absorber to fit on WALD Front Bumper.
※ The shape and size of OEM inner parts depend on Grade and Model. Therefore the pictures here are just for your reference.
Main idea is to adjust the shape of OEM inner parts to fit on WALD Front Bumper.



Fix OEM energy absorber to WALD Front Bumper after installing OEM under-grille bracket.
Check if OEM energy absorber interferes OEM PTS brackets or not.

Mercedes Benz E-class W212 (2013y~)

WALD SPORTS LINE
BLACK BISON EDITION

INSTALLATION MANUAL
WALD
Sportliche Autoausrüstung WALD.International

THANK YOU FOR PURCHASING. THIS IS THE INSTALLATION MANUAL OF WALD SIDE STEPS FOR MERCEDES-BENZ W212 E-CLASS.
PLEASE READ THIS MANUAL CAREFULLY BEFORE THE INSTALLATION.

ATTENTION



- ※ NO RETURNS CAN BE ACCEPTED BECAUSE OF IMPROPER INSTALLATION OR PAINTING.
- ※ CHECK THE FITMENT, AND ADJUST ALL THE DETAILS BEFORE PAINTING.
- We assume no responsibility for any damage resulting from improper installation, painting, modification and any cut wound in unsealing.
- Contact the car dealer when you have any question in removing OEM parts.
- During all the installation process, use parking brake and stop the engine completely.
- Use rasps or sandpapers to fit the products to the body if there is an individual difference.
- The product is made of FRP. Handle with care. Do not give the excessive force. Gradually fix the bolts and nuts by checking the fitment and balance of the installation.
- Check the fitment, and adjust all the details of the fitment steady and proper. Please check the fitment and all the details regularly, fix the bolts and nuts as necessary.
- The instruction of painting is just our recommendation, please paint it as you like.
- ※ PLEASE BE AWARE OF:
- You may lose the warranty and all the services from the car maker, because of replacing OEM parts.
- Reduced road clearance may cause inconvenience in using parking curbs and garage jack.
- FRP, ABS and PPE products are slightly weaker than OEM parts in crashes.
- The product may not match the body and OEM color perfectly.

Please purchase double sided tape, primer and caulking glue at auto accessory shop or hardware store.

Completely degrease and paint primer on all the installation positions to enhance the viscosity of double sided tape.
Use dryer to warm double sided tape to enhance the viscosity in low temperature.
Keep the car in a dry condition more than 24 hours after gluing.
Do not wash the car during this time.

	PARTS	QUANTITIES
SIDE STEPS	SIDE STEPS	1 SET

Use caulking glue to fill the gap between the product and the body.

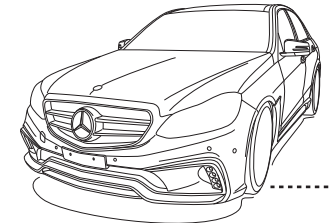

SIDE STEP

【BEFORE PAINTING】

- 1) Temporarily install WALD Side Steps to the body.
- ※ Adjust the details of WALD Side Steps to fit the body by rasps or sandpapers.
- 2) Use masking tape to mark the installation positions.
- 3) Paint WALD Side Steps according to the picture.

【AFTER PAINTING】

- 4) Completely degrease the installation positions, then use caulking glue to install WALD Side Steps to the body.
- 5) Check all the details of the fitment.
- 6) Use masking tape to fix WALD Side Steps to the body, then leave them till completely fixed.

※WALD SHOWCAR IS PAINTED LIKE THE PICTURE (STEP 3)

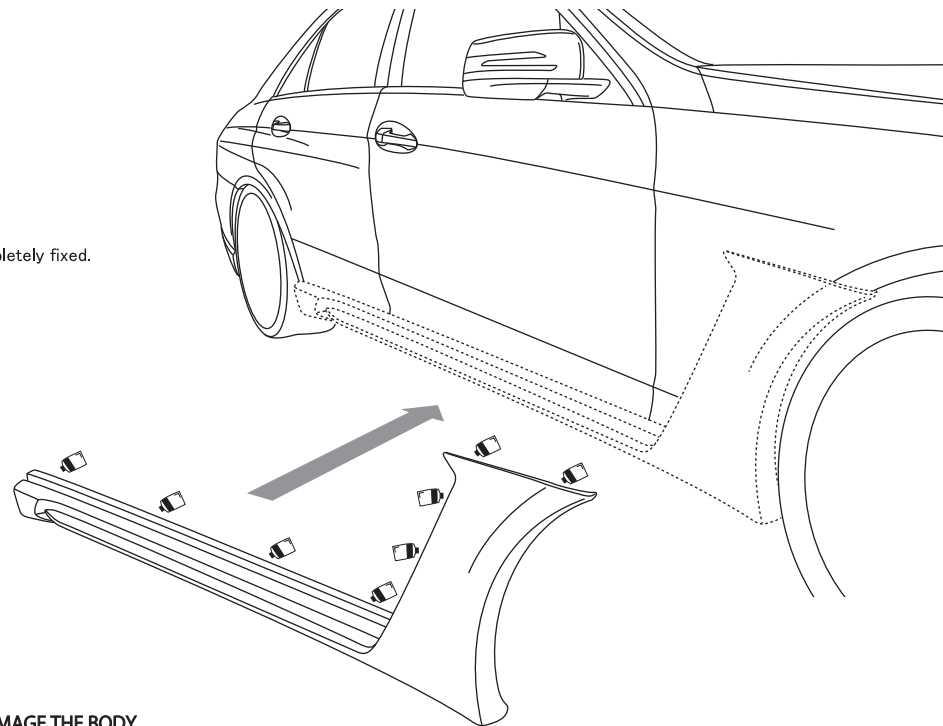
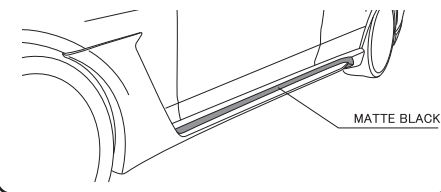

ATTENTION

- ※ MORE THAN 2 TECHNICIANS ARE NECESSARY IN THIS WORK. DURING ALL THE INSTALLATION PROCESS, PLEASE BE CAREFUL NOT TO DAMAGE THE BODY
- ※ DEGREASE ALL THE INSTALLATION POSITIONS, AND REMOVE THE BODY PROTECTION COATING BEFORE THE INSTALLATION..
- ※ ADJUST ALL THE DETAILS OF OUR PRODUCTS TO FIT ON A CAR PERFECTLY.

Mercedes Benz E-class W212 (2013y~)

WALD SPORTS LINE
BLACK BISON EDITION

INSTALLATION MANUAL
WALD
Sportliche Autoausrüstung WALD.International

THANK YOU FOR PURCHASING. THIS IS THE INSTALLATION MANUAL OF WALD REAR BUMPER FOR MERCEDES-BENZ W212 E-CLASS.
PLEASE READ THIS MANUAL CAREFULLY BEFORE THE INSTALLATION.

ATTENTION



- ※ NO RETURNS CAN BE ACCEPTED BECAUSE OF IMPROPER INSTALLATION OR PAINTING.
- ※ CHECK THE FITMENT, AND ADJUST ALL THE DETAILS BEFORE PAINTING.
- We assume no responsibility for any damage resulting from improper installation, painting, modification and any cut wound in unsealing.
- Contact the car dealer when you have any question in removing OEM parts.
- During all the installation process, use parking brake and stop the engine completely.
- Use rasps or sandpapers to fit the products to the body if there is an individual difference.
- The product is made of FRP. Handle with care. Do not give the excessive force. Gradually fix the bolts and nuts by checking the fitment and balance of the installation.
- Check the fitment, and adjust all the details of the fitment steady and proper. Please check the fitment and all the details regularly, fix the bolts and nuts as necessary.
- The instruction of painting is just our recommendation, please paint it as you like.
- ※ PLEASE BE AWARE OF:
- You may lose the warranty and all the services from the car maker, because of replacing OEM parts.
- Reduced road clearance may cause inconvenience in using parking curbs and garage jack.
- FRP, ABS and PPE products are slightly weaker than OEM parts in crashes.
- The product may not match the body and OEM color perfectly.

Please purchase double sided tape, primer and caulking glue at auto accessory shop or hardware store.

Completely degrease and paint primer on all the installation positions to enhance the viscosity of double sided tape.
Use dryer to warm double sided tape to enhance the viscosity in low temperature.
Keep the car in a dry condition more than 24 hours after gluing.
Do not wash the car during this time.

	PARTS	QUANTITIES
REAR BUMPER	REAR BUMPER	1
	LED LAMP WITH NUTS	1 SET
	MESHES	1 SET
	TOW HOOK COVER	1
	BRACKETS (Large, Medium, Small)	2 SETS
	BOLTS (M6 x 12) & NUTS	6 SETS
	TAPPING SCREWS (M5 x 16)	2

Use caulking glue to fill the gap between the product and the body.

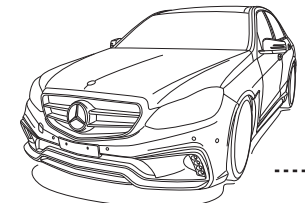

REAR BUMPER

【BEFORE PAINTING】

- 1) Remove OEM rear bumper according to the Mercedes-Benz service manual.
- 2) Make holes along the cutting line on WALD Rear Bumper for the car equipping PTS.
- 3) Temporarily relocate OEM bumper support to WALD Rear Bumper, then install it to the body with the attached brackets.
- ※ Adjust the details of WALD Rear Bumper to fit the body by rasps or sandpapers.
- 4) Mark the location of the holes for the attached tapping screws after checking the balance.
- 5) Take off WALD Rear Bumper from the body, then make holes according to the marked positions.
- 6) Paint WALD Rear Bumper according to the picture.

【AFTER PAINTING】

- 7) Use pins and caulking glue to install the attached meshes to WALD Rear Bumper from the rear.
- 8) Relocate all the necessary parts to WALD Rear Bumper, then temporarily install to the body.
- ※ As per enclosure for modifying OEM resin bracket.
- 9) Check all the details of the fitment, then fix them tightly.

※WALD SHOWCAR IS PAINTED LIKE THE PICTURE (STEP 6)

■ HOW TO INSTALL THE ATTACHED MESHES (STEP 7)

Use pins and caulking glue to install the attached meshes to WALD Rear Bumper from the rear.

※Paint the inside of the ducts and pins in black.

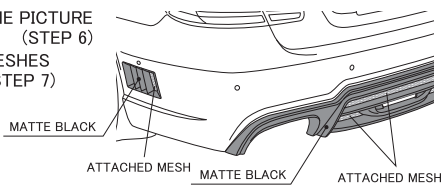

■ HOW TO INSTALL LED LAMP (STEP 8)

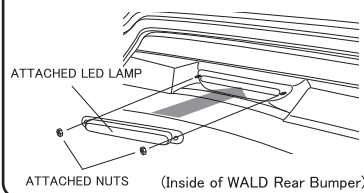

■ HOW TO INSTALL PTS (STEP 2, 8)

Remove OEM PTS and the basements, then use caulking glue to fix them to WALD Rear Bumper.
Make holes along the cutting line on WALD Rear Bumper.

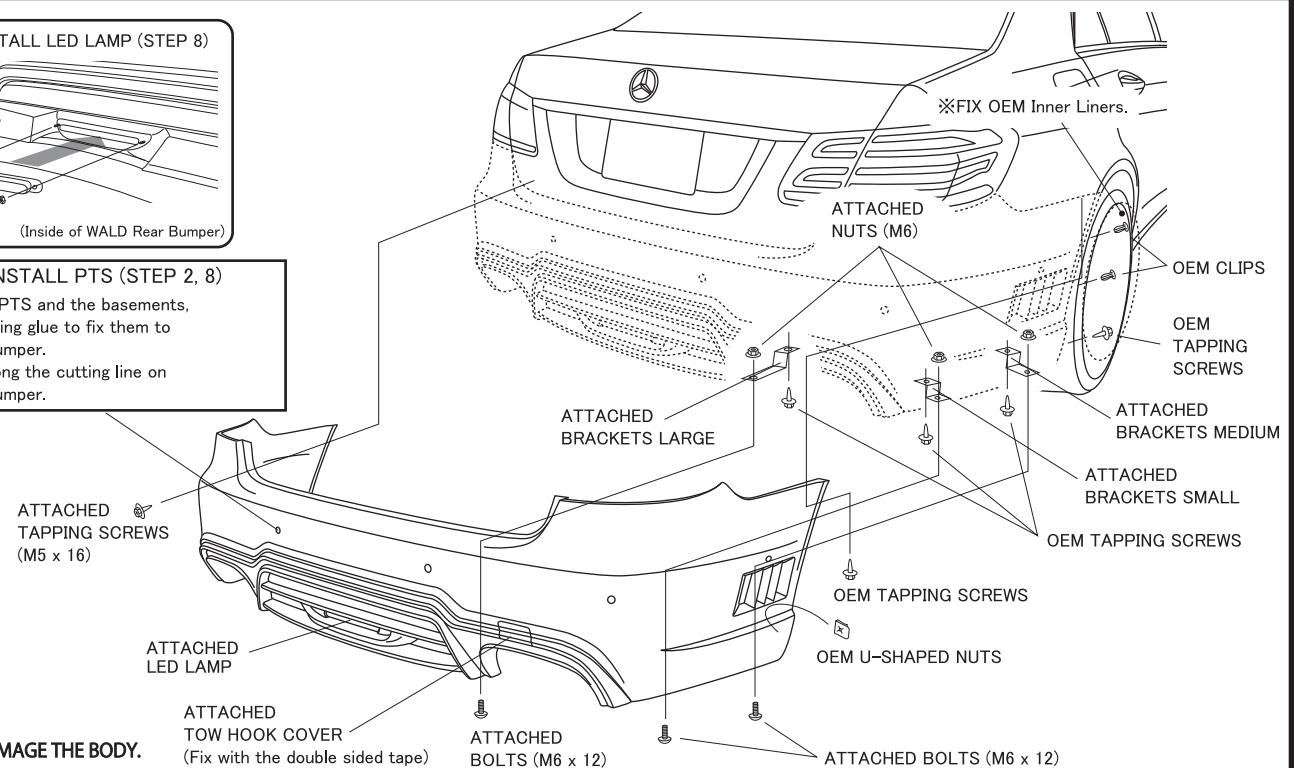

ATTENTION ※ MORE THAN 2 TECHNICIANS ARE NECESSARY IN THIS WORK.
DURING ALL THE INSTALLATION PROCESS, PLEASE BE CAREFUL NOT TO DAMAGE THE BODY.
※ ADJUST ALL THE DETAILS OF OUR PRODUCTS TO FIT ON A CAR PERFECTLY.

THANK YOU FOR PURCHASING. THIS IS THE INSTALLATION MANUAL OF HOW TO ADJUST OEM INNER PARTS TO FIT WITH WALD REAR BUMPER FOR W212 E-CLASS.

SIDE



Replace the red-circled OEM Sensors with the brackets to WALD Rear Bumper.

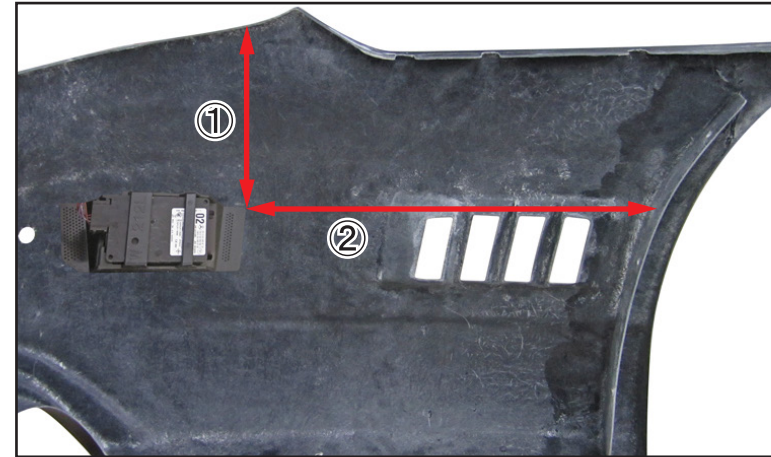

Use caulking glue to fix OEM brackets for PTS to WALD Rear Bumper.
Location for PTS : ①About 200 mm from the Top, ②About 460 mm from the inner-liner wall.

CENTER

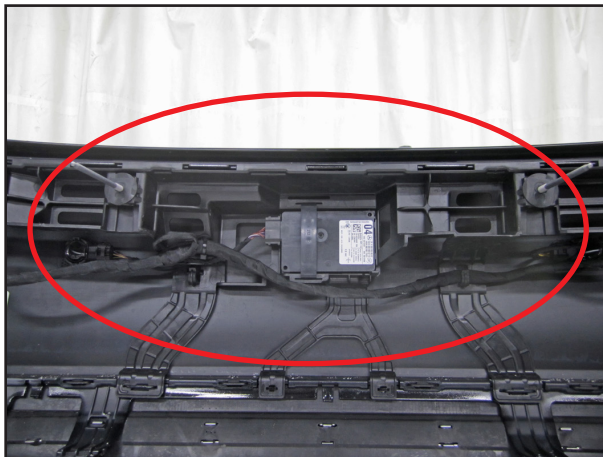

Replace the red circled OEM Sensor with the whole resin bracket to WALD Rear Bumper.

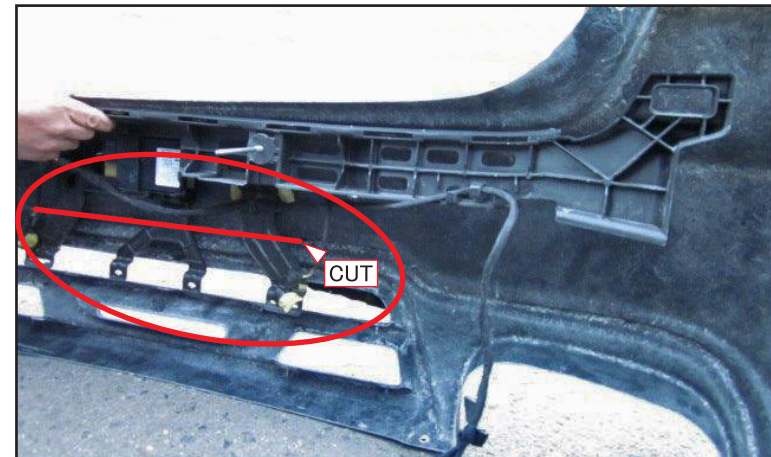

Cut the bottom part of OEM resin bracket according to the red line in the red circle after temporarily putting on WALD Rear Bumper.
Install WALD Rear Bumper to the body with OEM resin bracket because not available to fix OEM resin bracket to WALD Rear Bumper.

Mercedes Benz E-class W212 (2013y~)

WALD SPORTS LINE
BLACK BISON EDITION

INSTALLATION MANUAL
WALD
Sportliche Autoausrüstung WALD.International

THANK YOU FOR PURCHASING. THIS IS THE INSTALLATION MANUAL OF LED LAMPS ON WALD FRONT BUMPER FOR MERCEDES-BENZ W212 E-CLASS. PLEASE READ THIS MANUAL CAREFULLY BEFORE THE INSTALLATION.

ATTENTION



- ※ NO RETURNS CAN BE ACCEPTED BECAUSE OF IMPROPER INSTALLATION OR PAINTING.
- ※ CHECK THE FITMENT, AND ADJUST ALL THE DETAILS BEFORE PAINTING.
- We assume no responsibility for any damage resulting from improper installation, painting, modification and any cut wound in unsealing.
- Contact the car dealer when you have any question in removing OEM parts.
- During all the installation process, use parking brake and stop the engine completely.
- Use rasps or sandpapers to fit the products to the body if there is an individual difference.
- The product is made of FRP. Handle with care. Do not give the excessive force. Gradually fix the bolts and nuts by checking the fitment and balance of the installation.
- Check the fitment, and adjust all the details of the fitment steady and proper. Please check the fitment and all the details regularly, fix the bolts and nuts as necessary.
- The instruction of painting is just our recommendation, please paint it as you like.
- ※ PLEASE BE AWARE OF:
- You may lose the warranty and all the services from the car maker, because of replacing OEM parts.
- Reduced road clearance may cause inconvenience in using parking curbs and garage jack.
- FRP, ABS and PPE products are slightly weaker than OEM parts in crashes.
- The product may not match the body and OEM color perfectly.

Please purchase double sided tape, primer and caulking glue at auto accessory shop or hardware store.

Completely degrease and paint primer on all the installation positions to enhance the viscosity of double sided tape.
Use dryer to warm double sided tape to enhance the viscosity in low temperature.
Keep the car in a dry condition more than 24 hours after gluing.
Do not wash the car during this time.

	PARTS	QUANTITIES
LED LAMP	LED LAMP	1 SET
	REMOTE CONTROL HARNESS KIT	1

Use caulking glue to fill the gap between the product and the body.

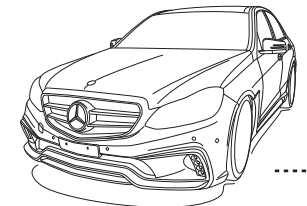

LED LAMP

【BEFORE PAINTING】

- 1) Temporarily fix the attached LED lamps according to the holes on WALD Front Bumper.
- ※ Adjust the details of WALD Front Bumper to fit the attached LED lamps by rasps or sandpapers.
- 2) Prepare to connect the attached LED lamps.
- ※ Insulate any spare harness.

【AFTER PAINTING】

- 3) Completely degrease the installation positions, then put the attached LED lamps according to the holes on WALD Front Bumper.
- 4) Use caulking glue to fix the attached LED lamps after checking the angle and location.
- 5) Leave them till completely fixed.
- 6) Install WALD Front Bumper to the body after connecting the harness.

■ HOW TO INSTALL THE ATTACHED LED LAMPS (STEP 1, 3)



Fix the attached LED lamps according to the picture.

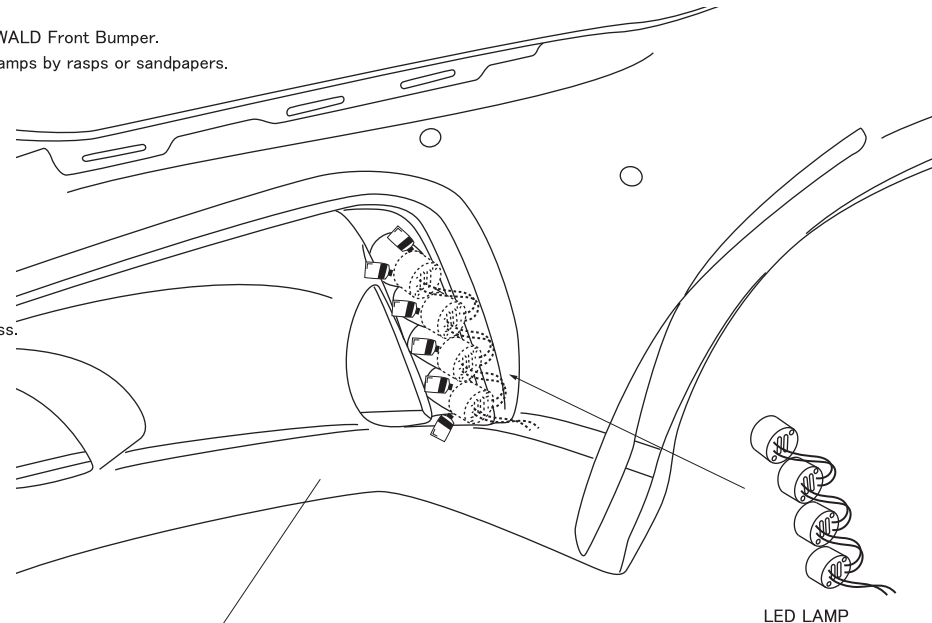

(Inside of WALD Front Bumper)

= WIRING DIAGRAM =

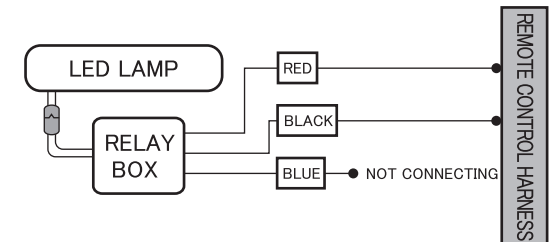

ATTENTION

- ※ REMOVE THE BATTERY BEFORE ALL THE WIRING WORKS.
- ※ MAKE SURE ATTACHED LED LAMPS ARE FINE TO WORK BEFORE THE INSTALLATION.

Mercedes Benz E-class W212 (2013y~)

WALD SPORTS LINE
BLACK BISON EDITION

INSTALLATION MANUAL
WALD
Sportliche Autoausrüstung WALD.International

THANK YOU FOR PURCHASING. THIS IS THE INSTALLATION MANUAL OF WALD FRONT BUMPER FOR MERCEDES-BENZ W212 E-CLASS.
PLEASE READ THIS MANUAL CAREFULLY BEFORE THE INSTALLATION.

ATTENTION



- ※ NO RETURNS CAN BE ACCEPTED BECAUSE OF IMPROPER INSTALLATION OR PAINTING.
- ※ CHECK THE FITMENT, AND ADJUST ALL THE DETAILS BEFORE PAINTING.
- We assume no responsibility for any damage resulting from improper installation, painting, modification and any cut wound in unsealing.
- Contact the car dealer when you have any question in removing OEM parts.
- During all the installation process, use parking brake and stop the engine completely.
- Use rasps or sandpapers to fit the products to the body if there is an individual difference.
- The product is made of FRP. Handle with care. Do not give the excessive force. Gradually fix the bolts and nuts by checking the fitment and balance of the installation.
- Check the fitment, and adjust all the details of the fitment steady and proper. Please check the fitment and all the details regularly, fix the bolts and nuts as necessary.
- The instruction of painting is just our recommendation, please paint it as you like.
- ※ PLEASE BE AWARE OF:
- You may lose the warranty and all the services from the car maker, because of replacing OEM parts.
- Reduced road clearance may cause inconvenience in using parking curbs and garage jack.
- FRP, ABS and PPE products are slightly weaker than OEM parts in crashes.
- The product may not match the body and OEM color perfectly.

Please purchase double sided tape, primer and caulking glue at auto accessory shop or hardware store.

Completely degrease and paint primer on all the installation positions to enhance the viscosity of double sided tape.
Use dryer to warm double sided tape to enhance the viscosity in low temperature.
Keep the car in a dry condition more than 24 hours after gluing.
Do not wash the car during this time.

	PARTS	QUANTITIES
TRUNK SPOILER & ROOF SPOILER	TRUNK SPOILER	1
	ROOF SPOILER	1

Use caulking glue to fill the gap between the product and the body.

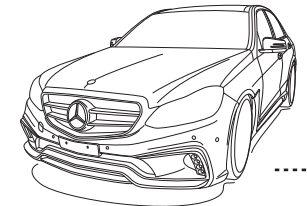

TRUNK SPOILER & ROOF SPOILER

【BEFORE PAINTING】

- 1) Temporarily install WALD Trunk Spoiler and Roof Spoiler to the body.
- 2) Check the fitment, then use masking tape to mark the installation positions.

【AFTER PAINTING】

- 3) Replace OEM Emblem from the body to WALD Trunk Spoiler.
- ※ Completely degrease the installation position, then use double sided tape.
- 4) Completely degrease the installation positions, then use caulking glue to install WALD Trunk Spoiler and Roof Spoiler to the body according to the marked position.
- ※ Fold the both ends of release paper to adjust the location of using double sided tape.
- 5) Check all the details of the fitment.
- 6) Leave them till completely fixed.

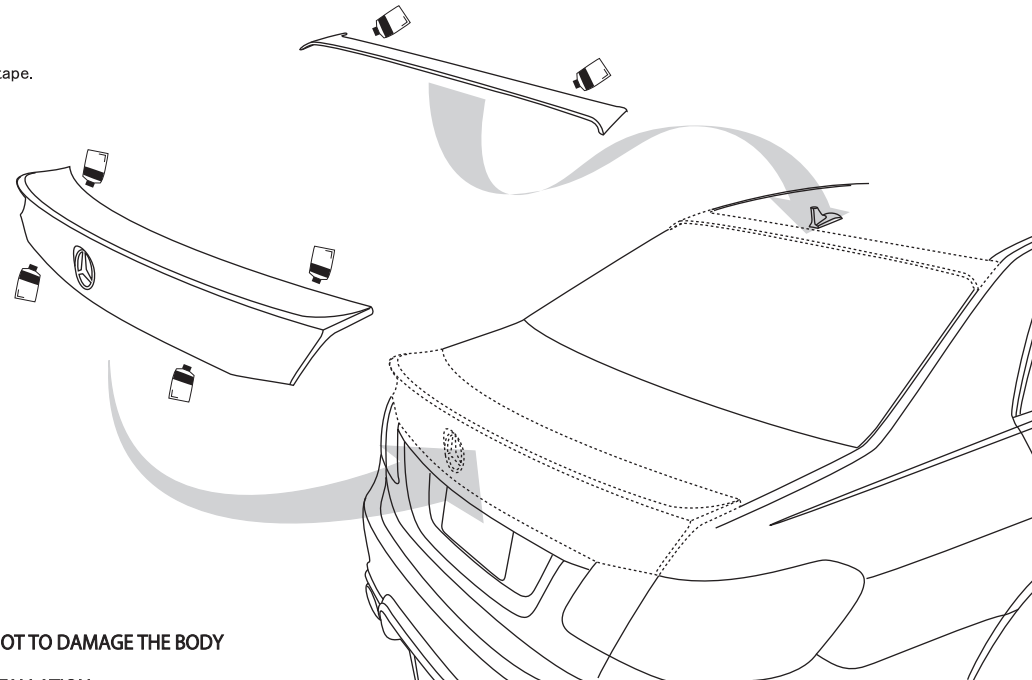

ATTENTION

- ※ MORE THAN 2 TECHNICIANS ARE NECESSARY IN THIS WORK. DURING ALL THE INSTALLATION PROCESS, PLEASE BE CAREFUL NOT TO DAMAGE THE BODY
- ※ DEGREASE ALL THE INSTALLATION POSITIONS, AND REMOVE THE BODY PROTECTION COATING BEFORE THE INSTALLATION..